

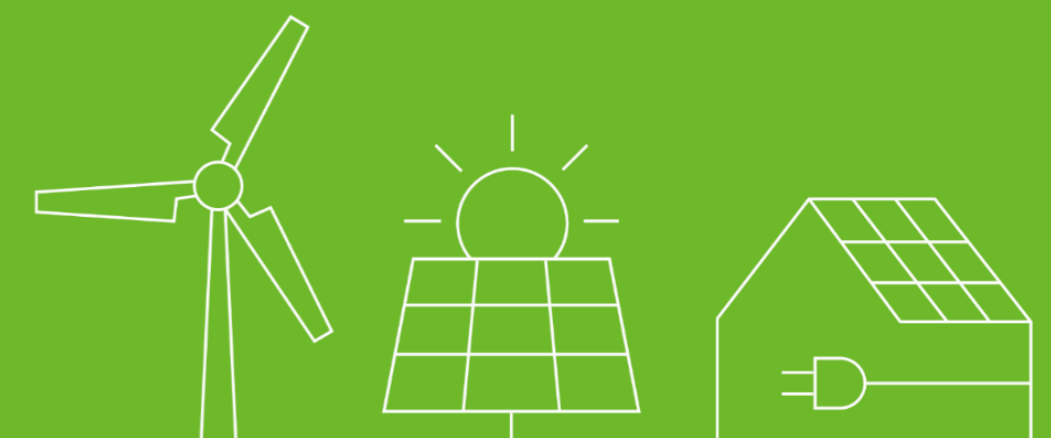

SPF 3500-5000ES + AXE Lithium Battery Off-Grid Energy Storage System



SHENZHEN GROWATT NEW ENERGY CO.,LTD

GROWATT



CONTENTS

- 01 **Product Overview**
- 02 **Higher Yield**
- 03 **Flexible & Scalable**
- 04 **Smart & Reliable**
- 05 **AXE Lithium Battery**
- 06 **Application Scenarios**

01

Product Overview



Off-Grid System Overview

Off-grid energy storage system is generally consist of PV modules, off-grid inverter, battery, generator or utility power, monitoring devices and electrical appliances.

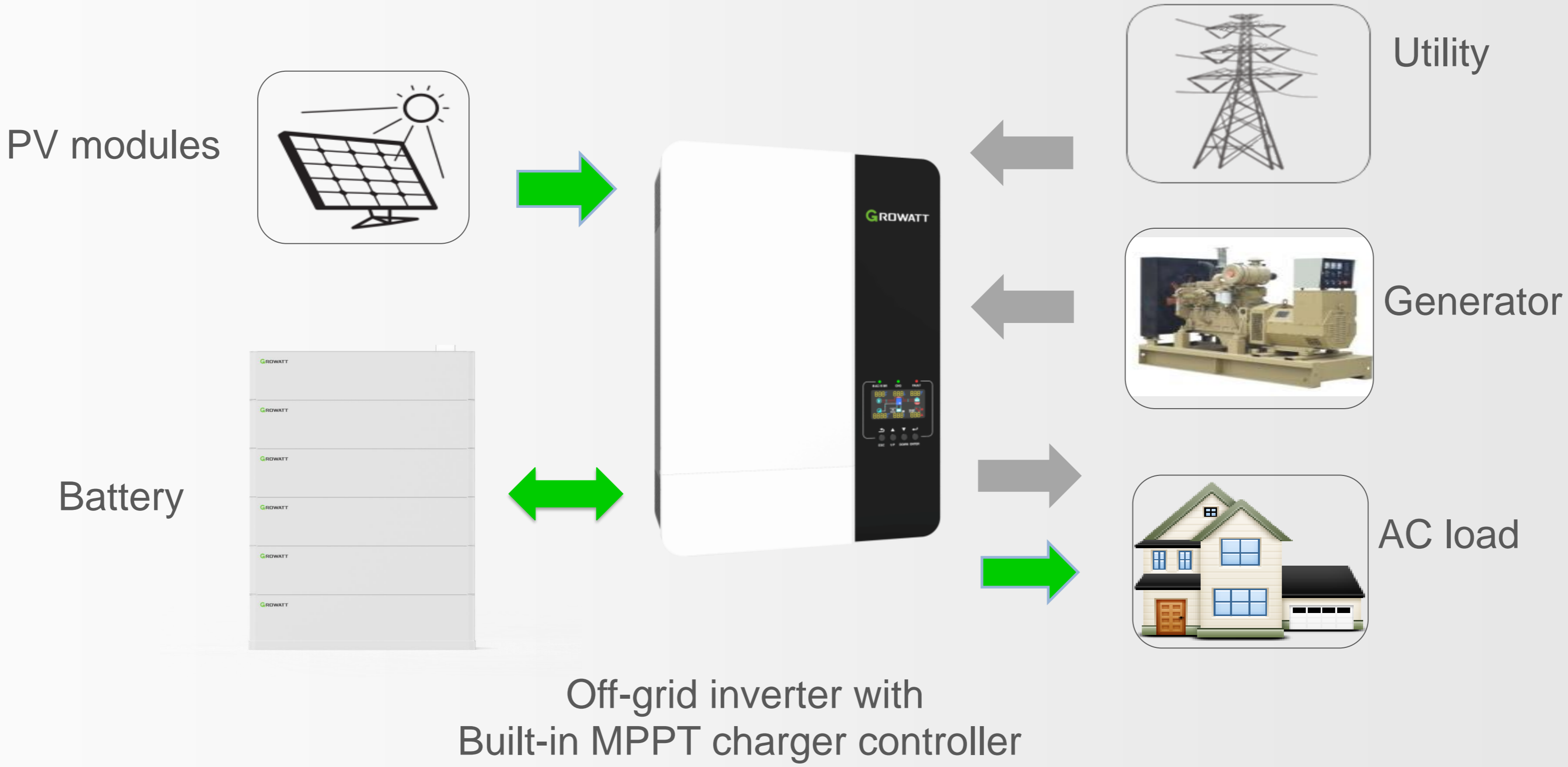

ES Series Features:



SPF 3500-5000ES

Key Feature

1. Compatible with Lithium battery
2. Wide PV input voltage range up to 450Vdc
3. SUB function to support solar and utility jointly power the load
4. Parallel for scalability or three phase operation up to 6 units
5. Work with or without battery
6. Support generator input
7. Equalization charging function for lead-acid battery
8. LCD display and WiFi/GPRS monitoring & smart control

AXE Battery Key Features

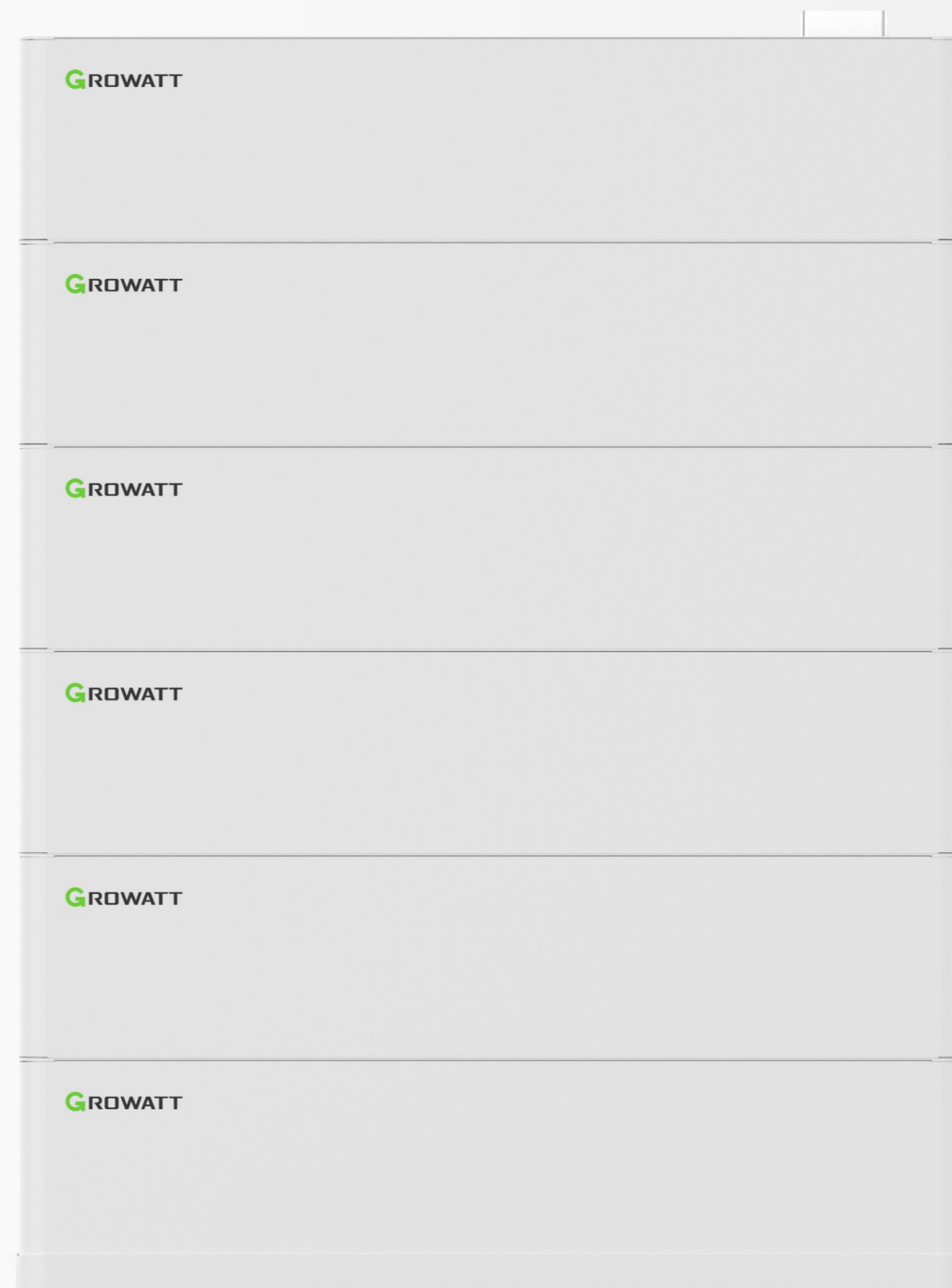

AXE Low Voltage Battery System

5.0kWh / Module

Single Cluster: 5.0kWh ~ 50kWh

Max. 8 clusters up to 400kWh

LFP battery, extreme safe

Internal plug connection, easy installation

02

Higher Yield



Power Factor 1.0

Power factor : 1.0

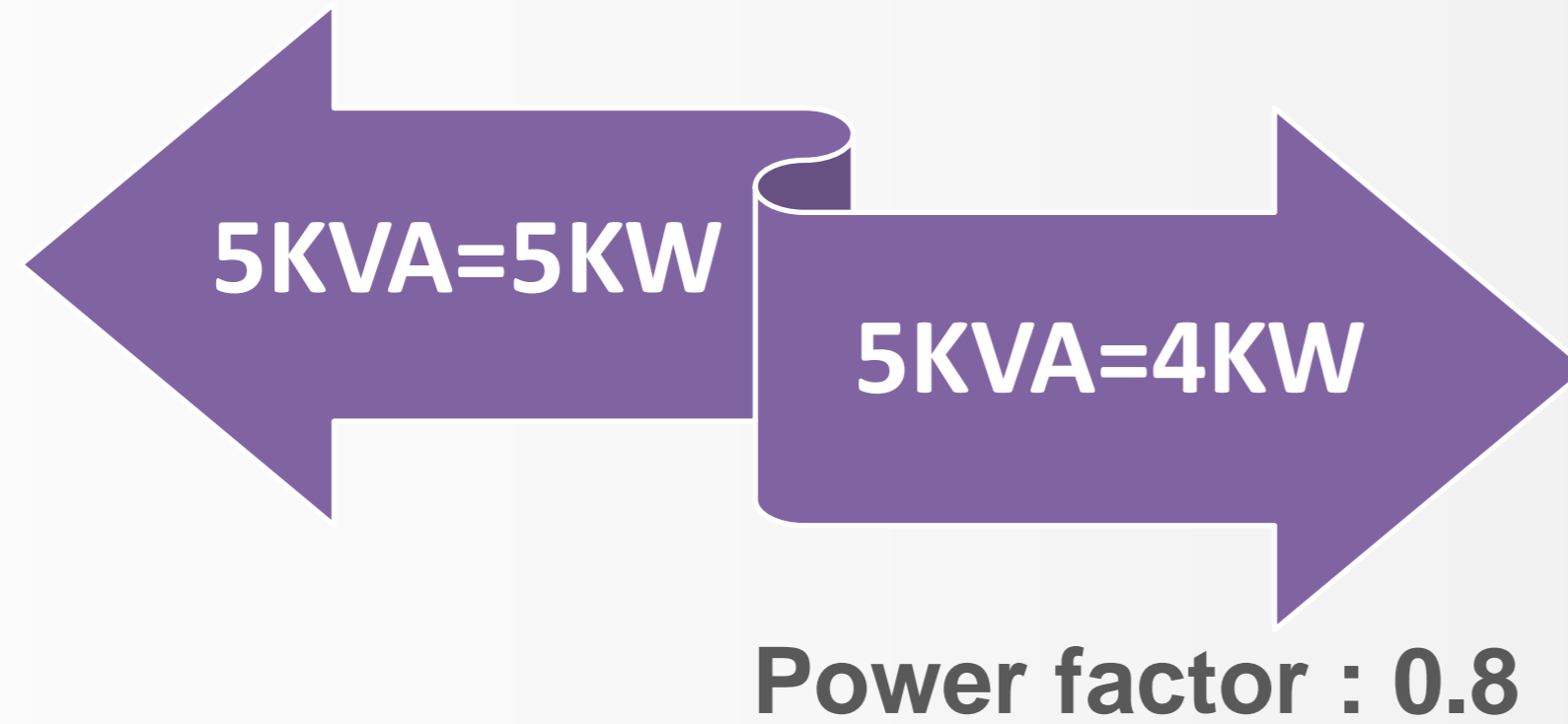

More Powerful

Output power factor: 1.0 (5KVA & 5KW)



Inverter 100% load, still work normally

Over-load 125%, inverter stop working

5KW Power Appliances

High DC/AC Ratio up to 1.2

6KW PV input support the full load output and additional energy to charge the battery.

General 5KVA inverter

Maximum 4500Wp PV input, need additional SCC for battery charging

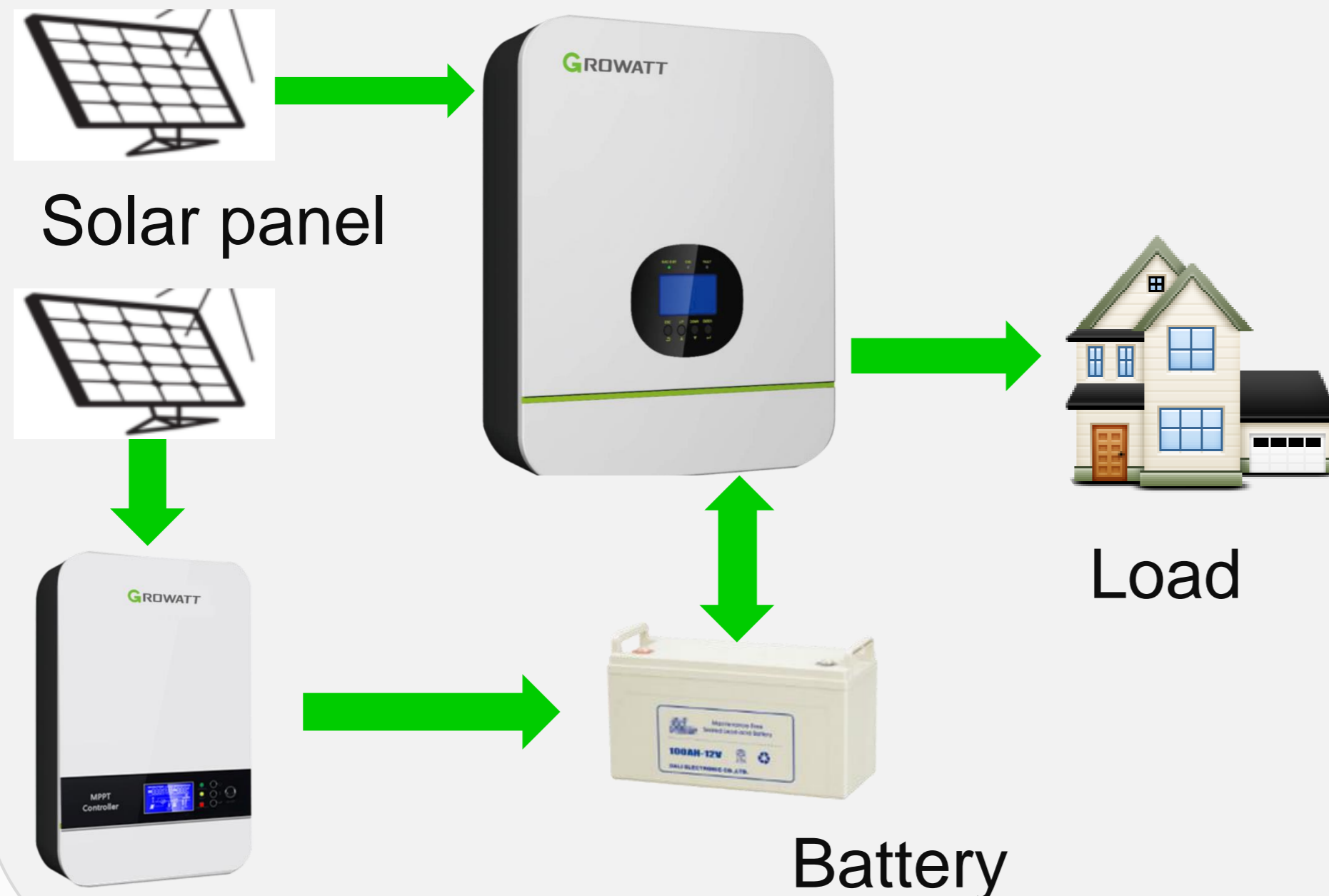

Solar Charger Controller (SCC)

SPF 5000ES

Maximum 6000Wp PV input, enough energy both for load and battery

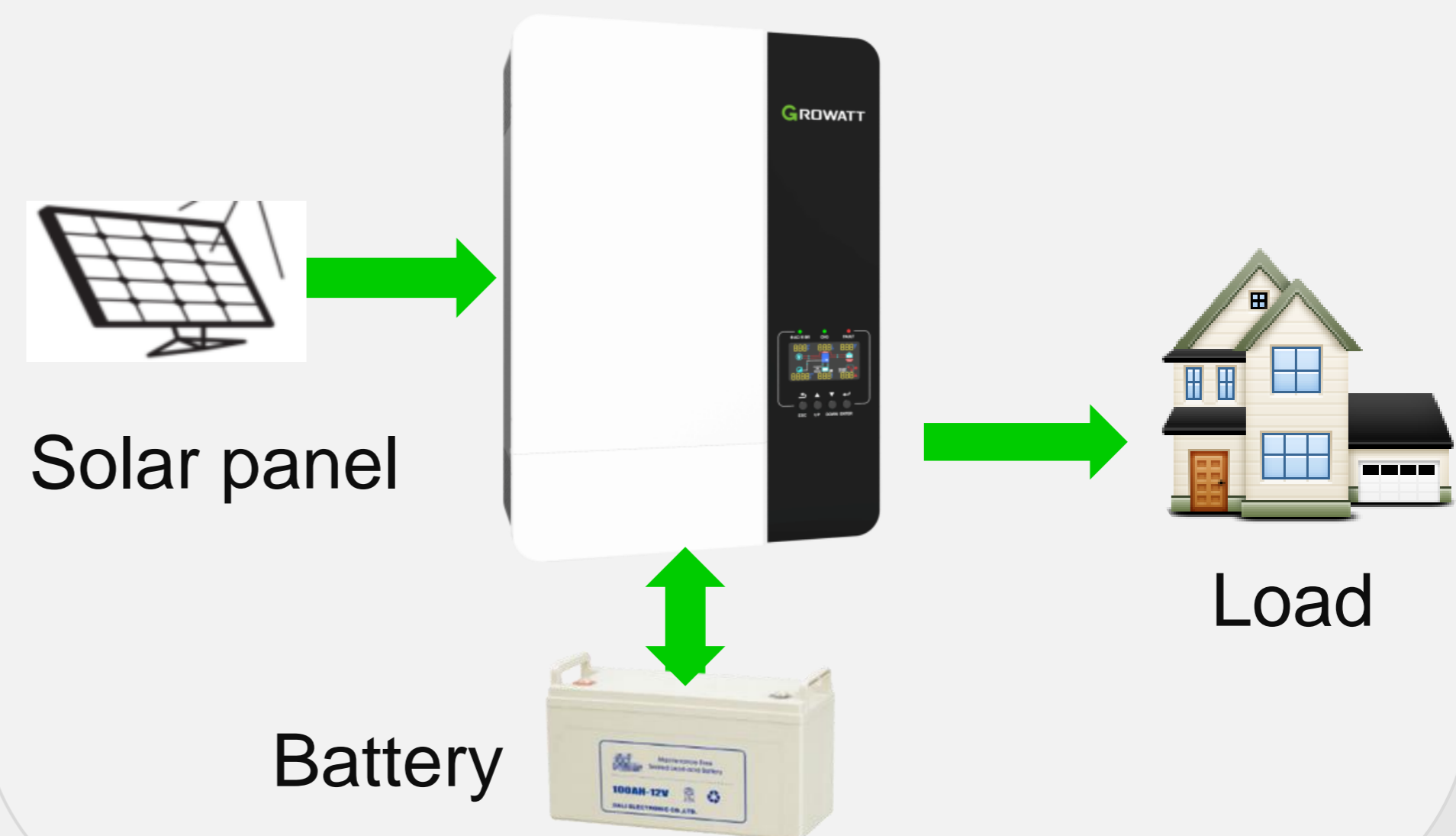

03

Flexible & Scalable

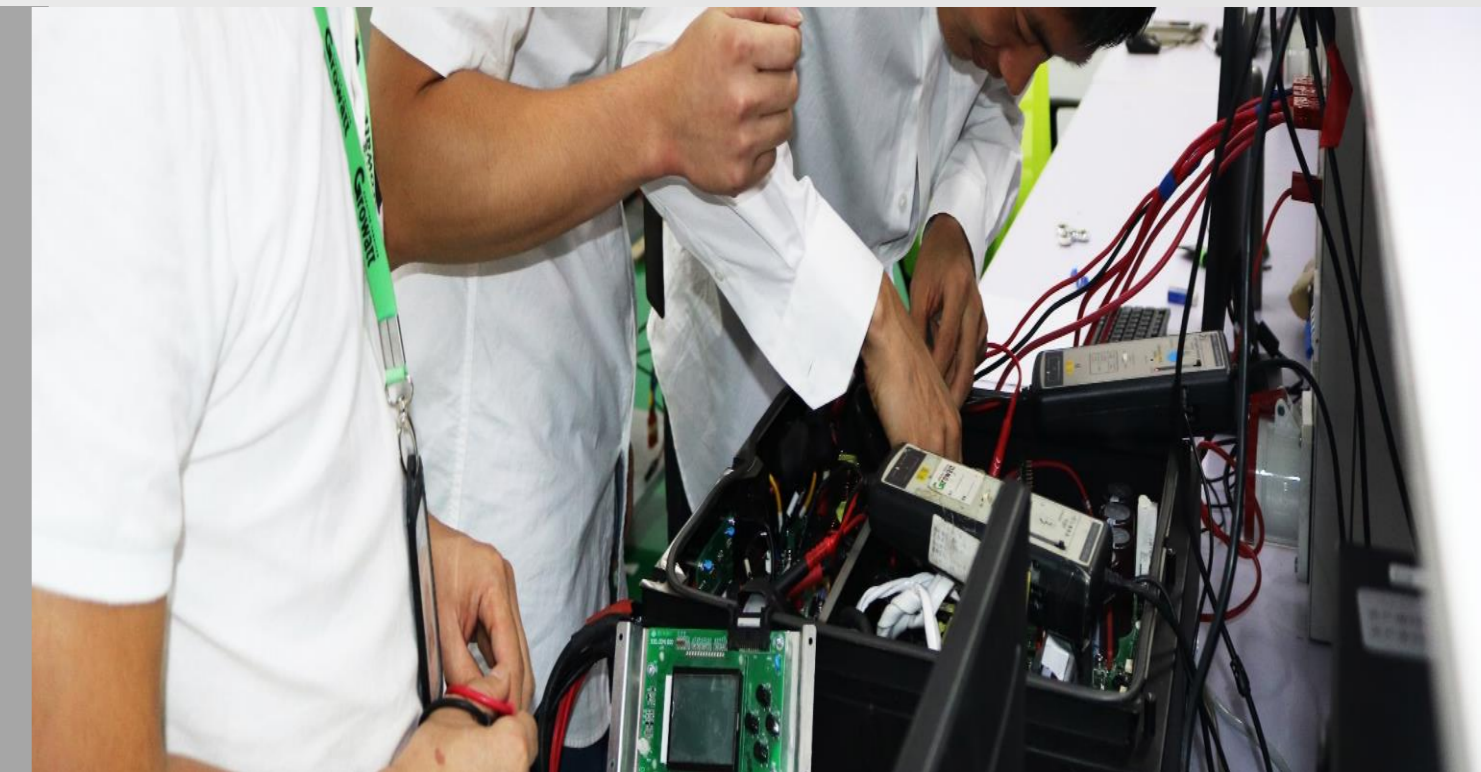

Higher PV Input Range



General inverter application
Max. PV Input is 145VDC

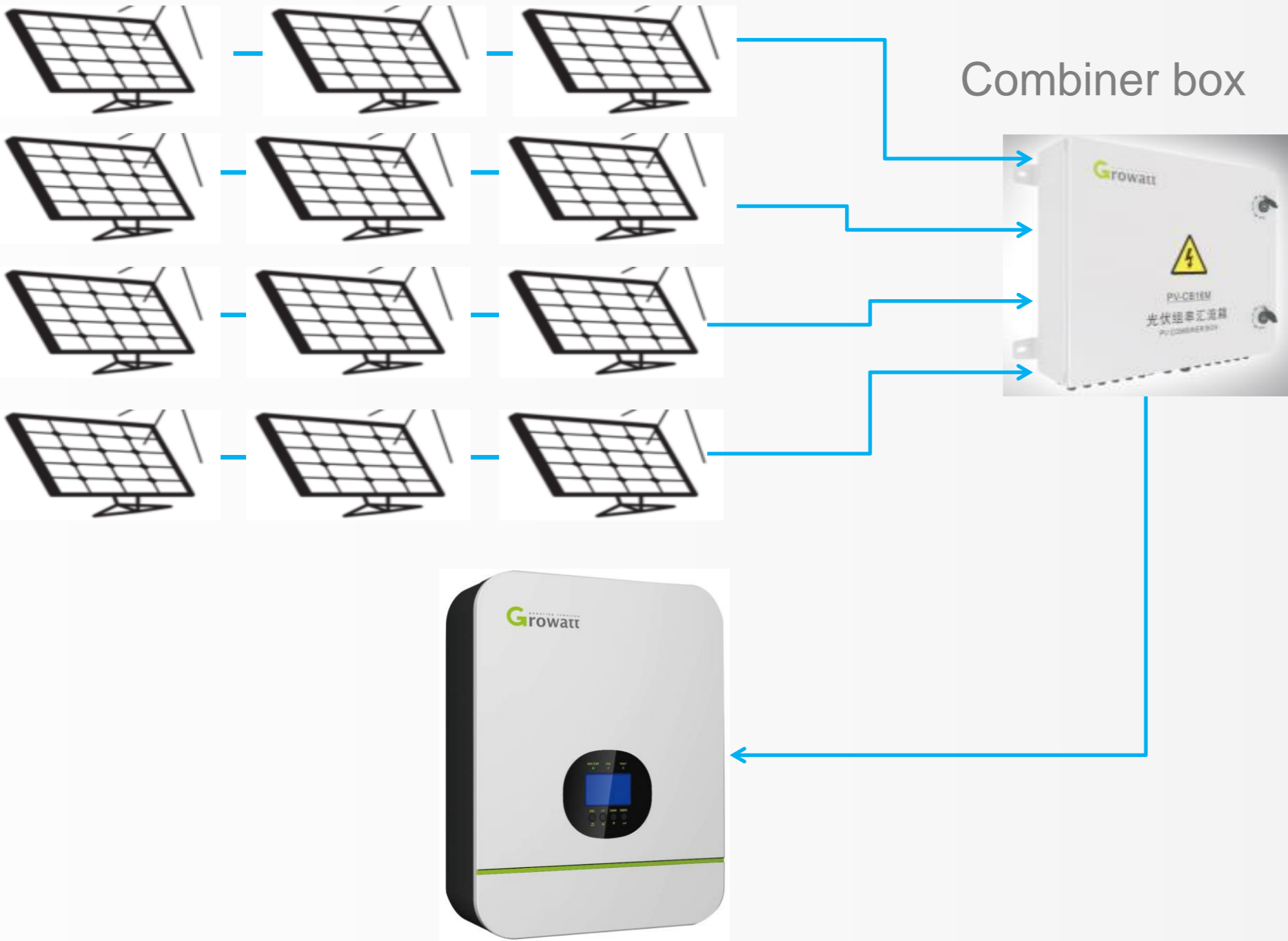

SPF 2000-5000TL HVM (old version)

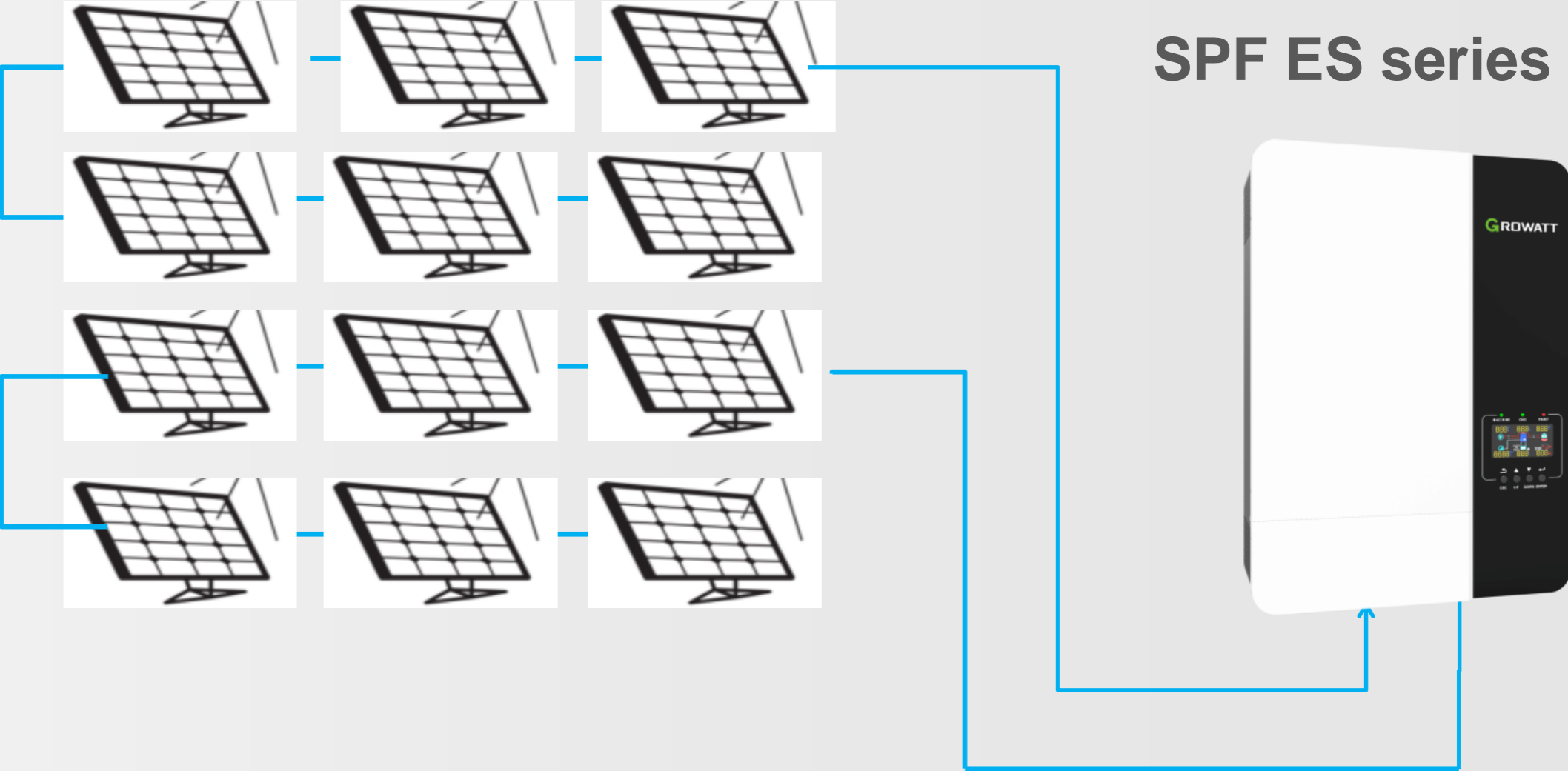

ES series inverter PV input range up to **450VDC**, no need additional combiner box, which is convenient for installation and save the wiring cost.

Parallel Extension

Parallel operation up to 6 units, the maximum system capacity would be 30kW, also support to configure three-phase system, provide customer enough flexibility.

Three-phase system

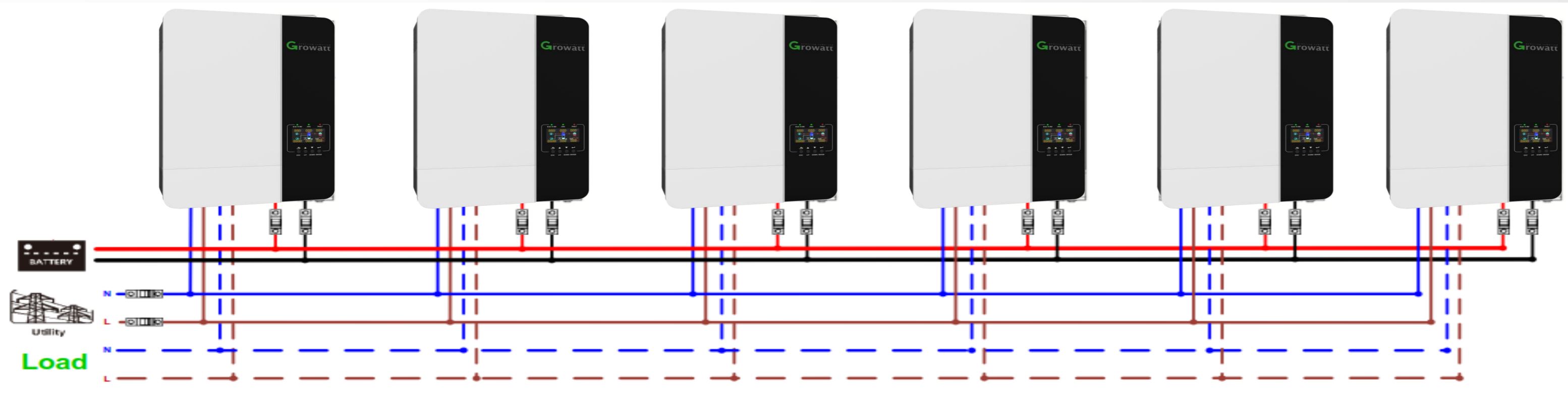
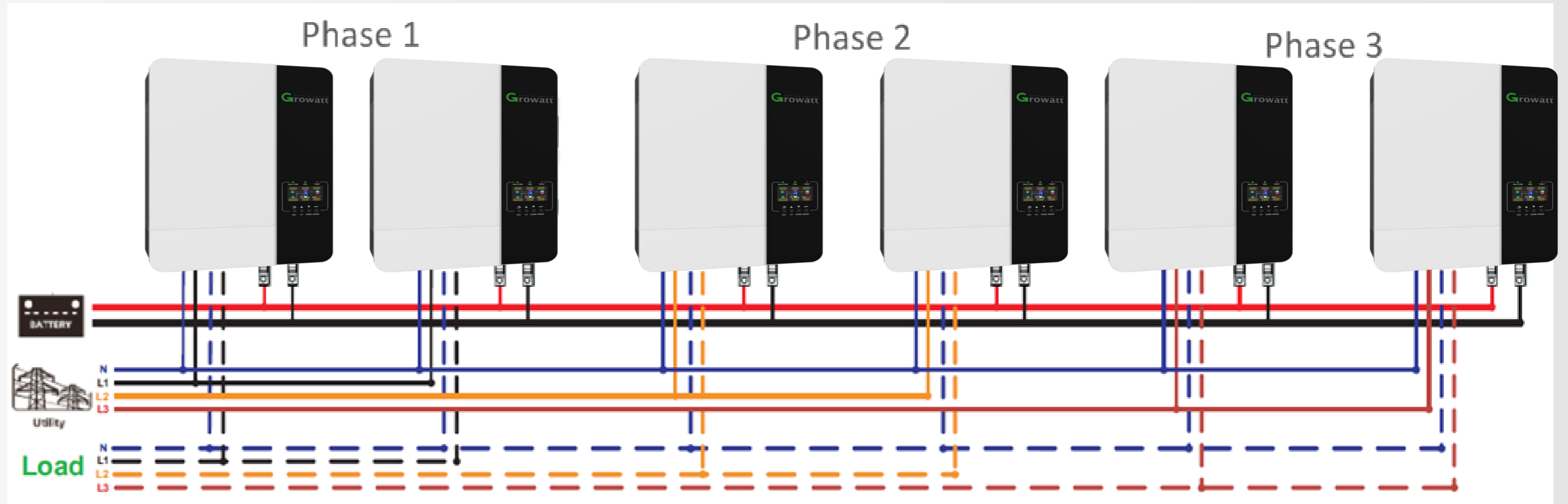

Single-phase system

Parallel Connection

Single phase parallel:

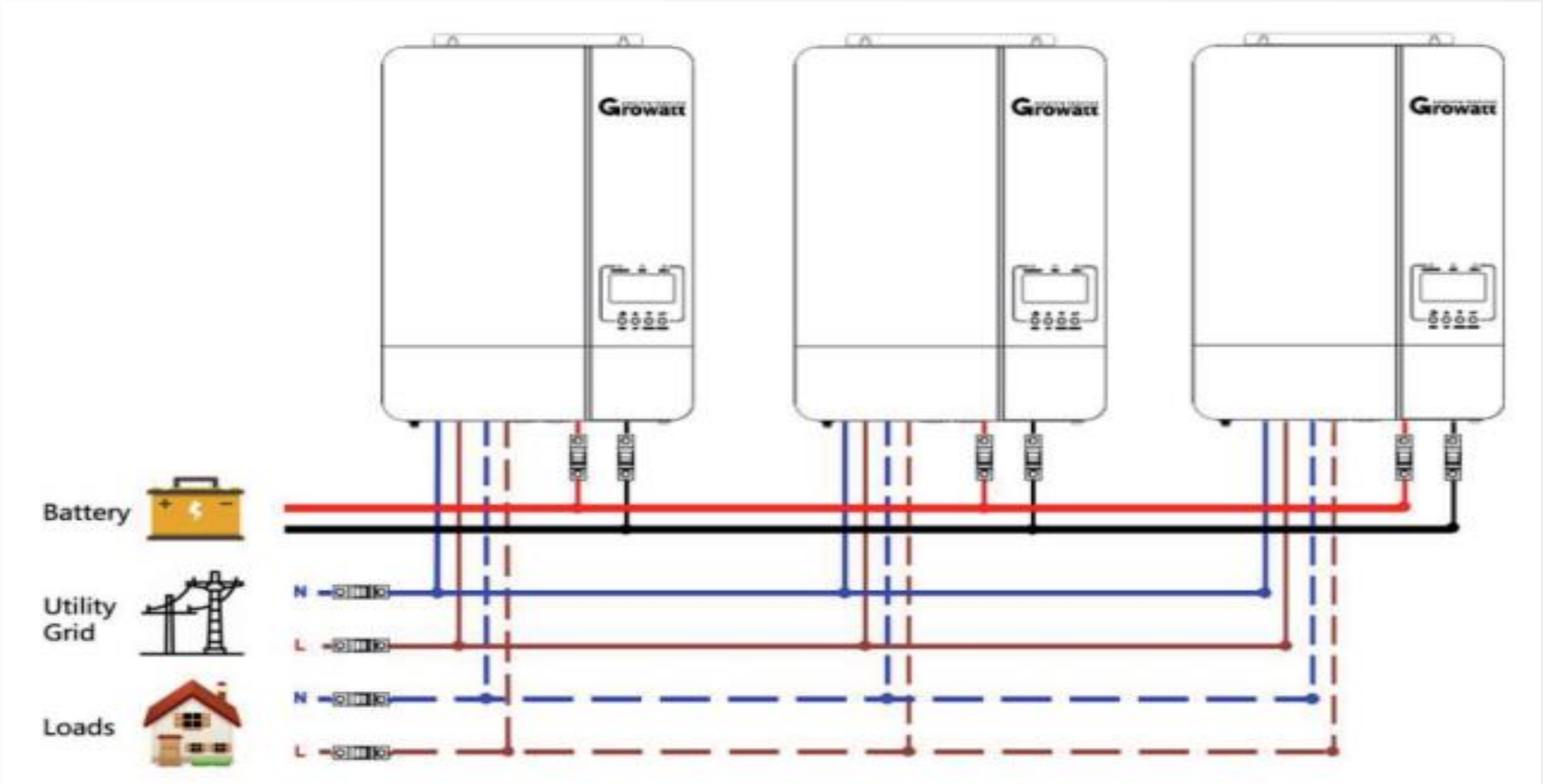

Communication connection:

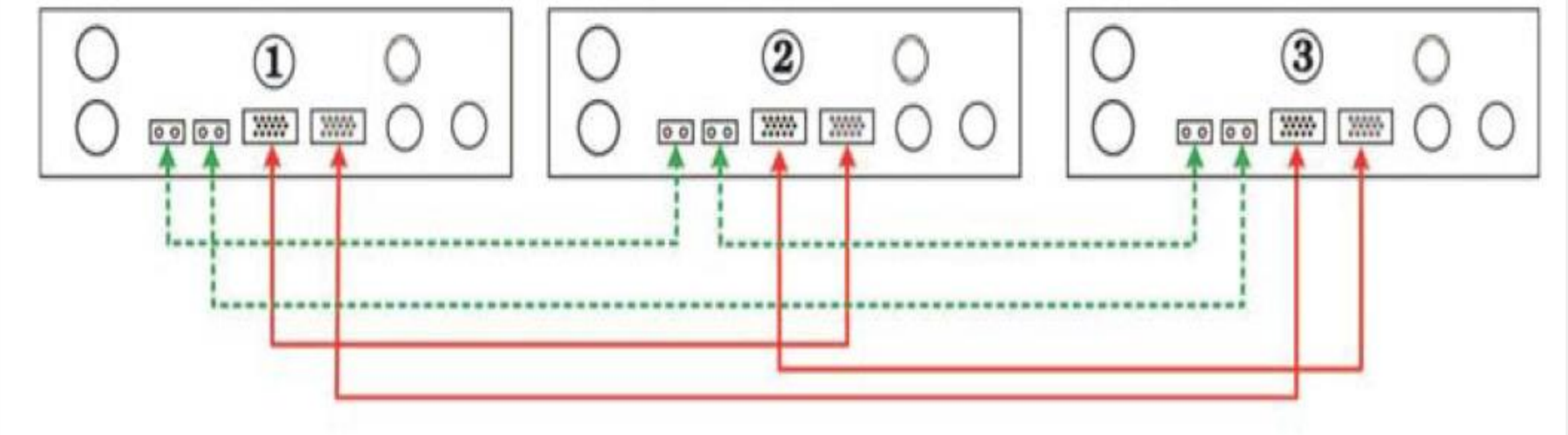

When the units are used in **parallel** with **single-phase**, please select "PAL" in program 23.

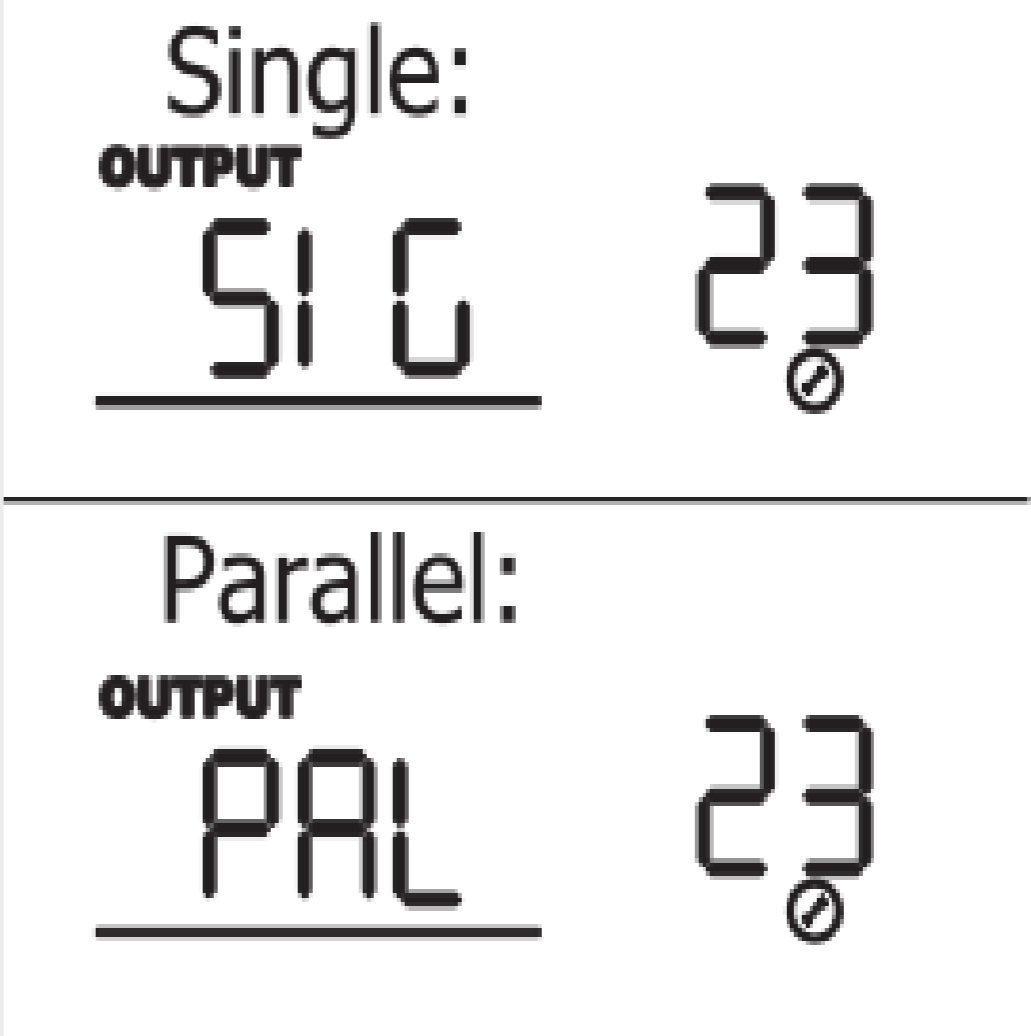

Note: Please connect the current sharing cable for same phase inverters which is like the green color wire and connect parallel communication cable between the each inverters as the red cable .

Parallel Connection

Three phase parallel:

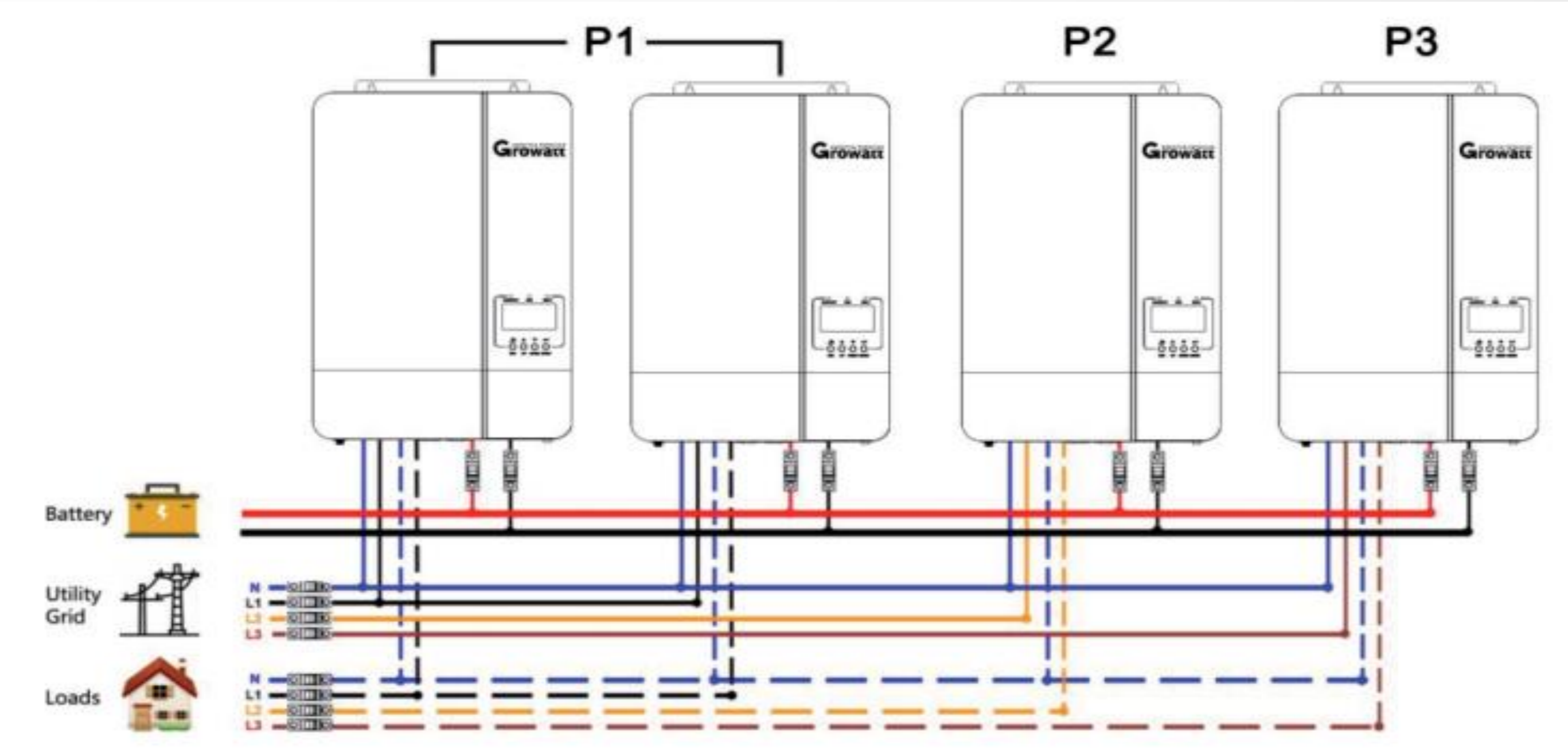

When units are used in parallel with three-phase, please select "3P1" for L1, "3P2" for L2, and "3P3" for L3 in program 23. All neutral lines must be connected.

L1 phase:	
OUTPUT	
<u>3P1</u>	23
L2 phase:	
OUTPUT	
<u>3P2</u>	23
L3 phase:	
OUTPUT	
<u>3P3</u>	23

Communication connection:

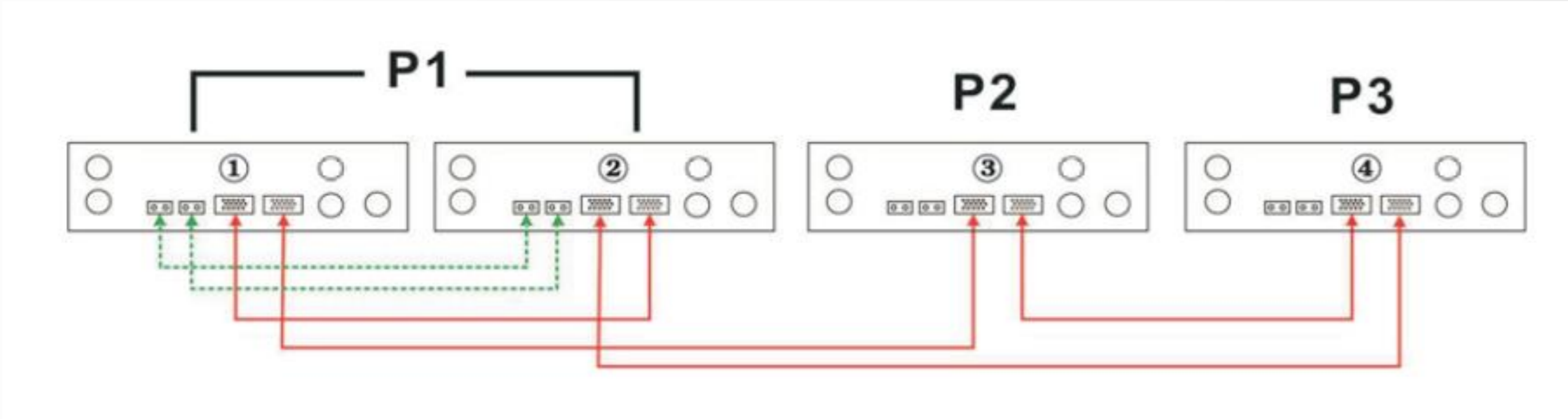

Note: Please connect the current sharing cable for same phase inverters which is like the green color wire and connect parallel communication cable between the each inverters as the red cable .

Setting Operation

Parallel mode setting step:

Press “UP” or “DOWN” button to select setting programs. Then press “ENTER” button to confirm



Single phase parameter setting



Three phase parameter setting

Pressing and holding ENTER button for 3 seconds.

Work Without Battery

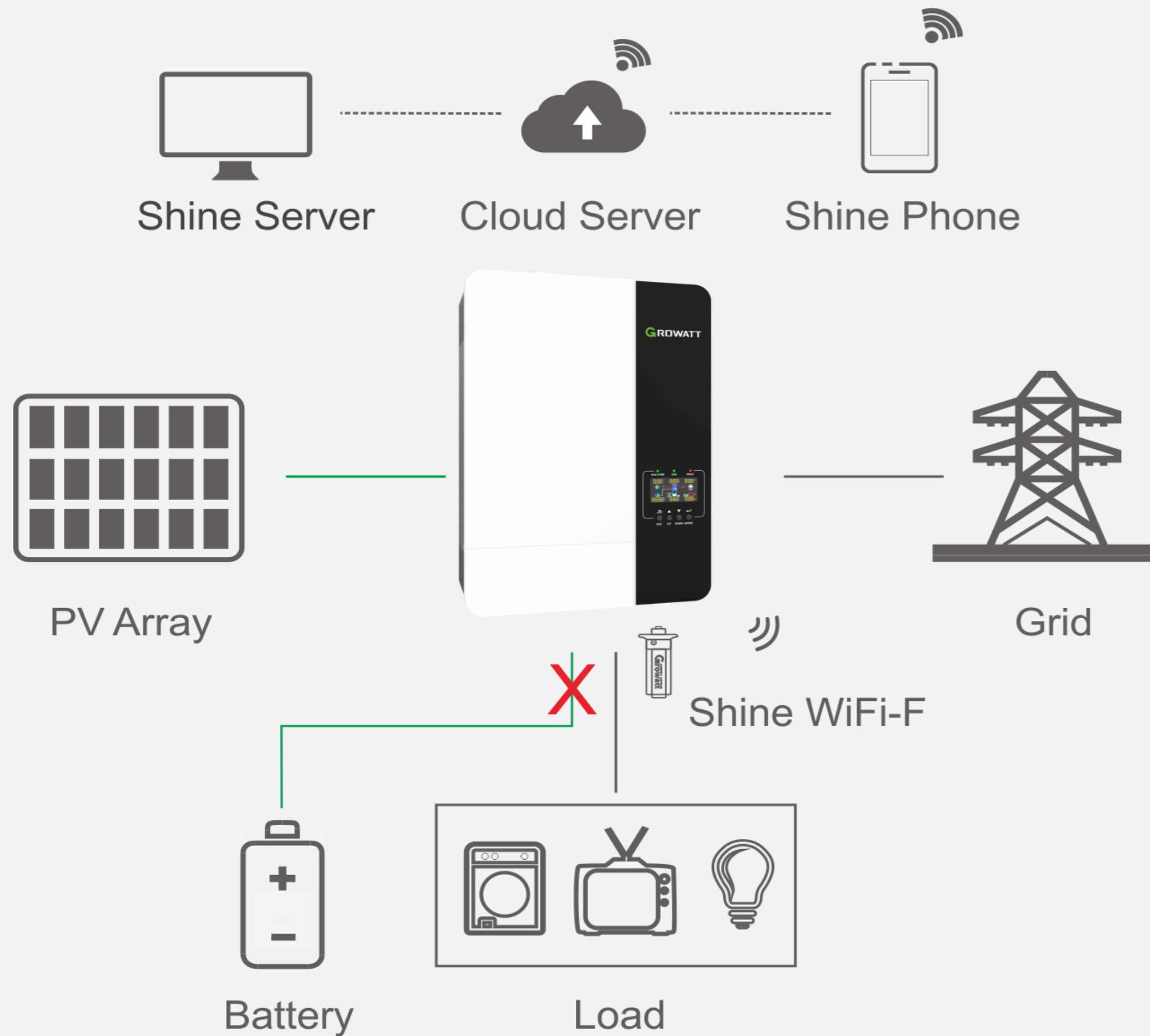

1. Directly connect solar panel , without battery and grid operation mode
2. Directly connect Grid power , without battery and solar operation mode
3. Directly connect solar panel and grid power without battery operation mode
4. Connect battery optional for energy storage and back-up support

CAN/RS485 Communication with Lithium Battery



Inverter built-in BMS port which include RS485 and CAN communication, and then easy to connect to different communication methods of lithium batteries.



Setting operation

Battery type setting step:



Pressing and holding ENTER button for 3 seconds.



1. AGM, Flooded, User-Defined battery type can be selected (For lead-acid battery)



2. Lithium , User-Defined 2 (lithium battery without communication) type can be selected (For Lithium battery)

Note: for Lithium battery please select correct communication protocol base on different brand battery.

Lithium Battery Communication protocol



Battery		High Frequency Inverter (Off-grid)					
Brand	Model	Protocol type	SPF 5000TL HVM SPF 5000TL HVM-P	SPF 3000TL LVM-48P	SPF 3000TL HVM-48	SPF 5000TL HVM-WPV SPF 5000TL HVM-WPV-P	SPF 3500-5000ES SPF 3000TL LVM-ES
Growatt	ARK 2.5L-A1/ AXE 5.0L-A1	L51	CAN	CAN	CAN	CAN	CAN
PYLON TECH	US2000 / US2000(New version)	L52/L04	CAN/RS485	CAN/RS485	CAN/RS485	CAN/RS485	CAN/RS485
PYLON TECH	US2000 PLUS/ US2000 PLUS(New version)	L52/L04	CAN/RS485	CAN/RS485	CAN/RS485	CAN/RS485	CAN/RS485
Growatt	Hope 4.8L-C1	L51	CAN	CAN	CAN	CAN	CAN
Growatt	Hope 3.3L-C1	L51	CAN	CAN	CAN	CAN	CAN
DYNESS	B4850	L01	RS485	RS485	RS485	RS485	RS485
Battery		Low Frequency Inverter (Off-grid)					
Brand	Model	Protocol type	SPF4-6KT HVM SPF 4000-6000T DVM	SPF8-12KT HVM SPF 8000-12000T DVM	SC 4860-120 SC 4860-120-MPV	SPF 3000T HVM-G2	SPF 6-12KT DVM-MPV
PYLON TECH	US2000 / US2000(New version)	L52/L04	CAN/RS485	*	CAN/RS485	CAN/RS485	*
PYLON TECH	US2000 PLUS/ US2000 PLUS(New version)	L52/L04	CAN/RS485	*	CAN/RS485	CAN/RS485	*
DYNESS	B4850	L01	RS485	RS485	RS485	RS485	RS485
Growatt	Hope 4.8L-C1	L51	CAN	CAN	CAN	CAN	CAN
Growatt	Hope 3.3L-C1	L51	CAN	CAN	CAN	CAN	CAN
Growatt	ARK 2.5L-A1	L51	CAN	CAN	CAN	CAN	CAN

04

Smart & Reliable

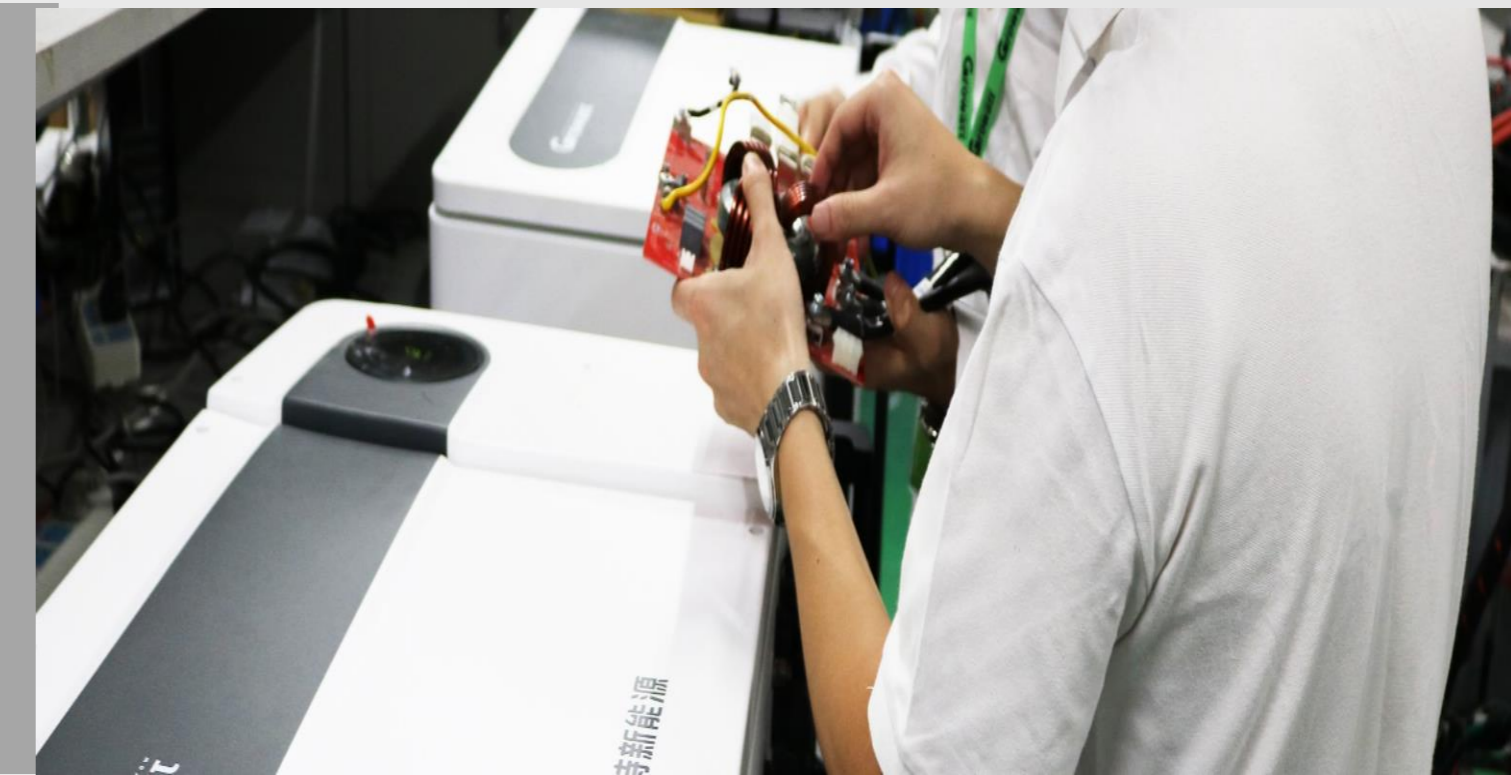

Convenient HMI



Colorful LCD display

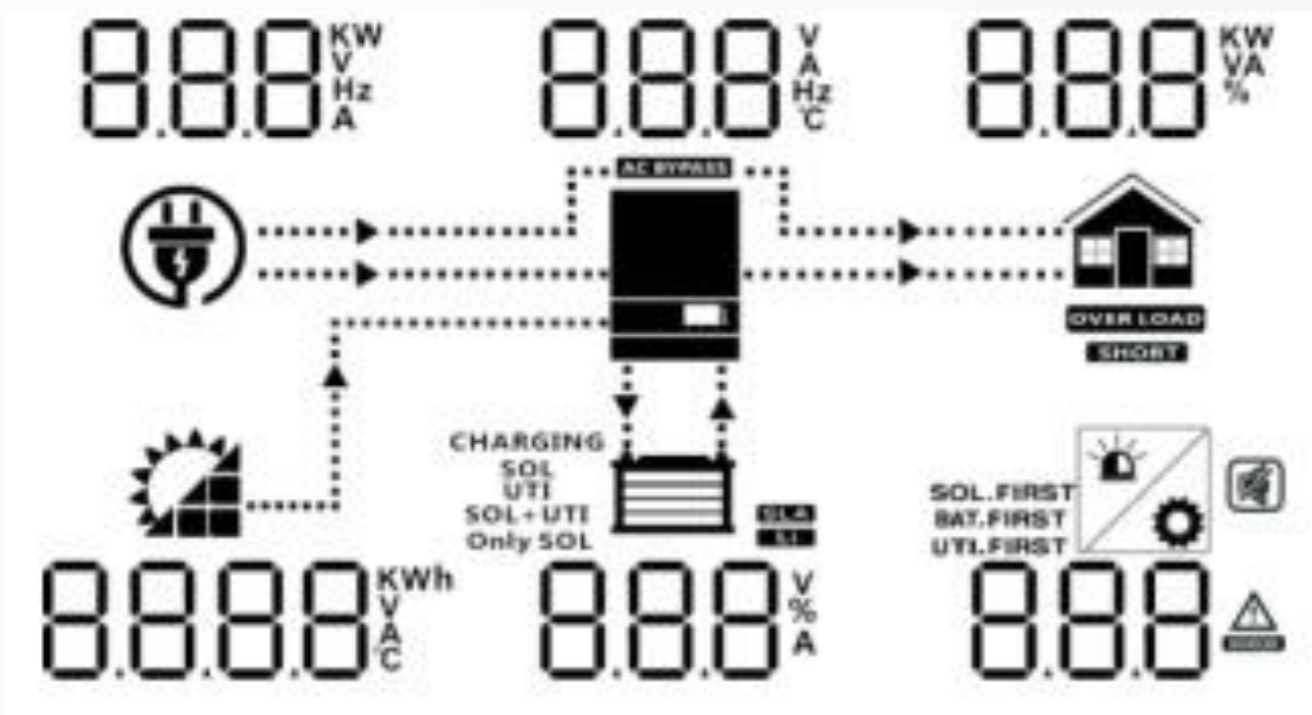

ES series



USB cable



PC install monitoring software

PVkeeper platform for local configuration or monitoring.

1. Input information (PV voltage, AC voltage, frequency, PV generation, battery voltage, charger current)

2. Output information (voltage, load percentage, frequency, load in VA, load in watt, discharging current)



Smart Management



Remote monitoring,
Support remote FW upgrade

WIFI, GPRS communication port for remote monitoring



WIFI-F



GPRS-F



ShinePhone APP



ShineServer

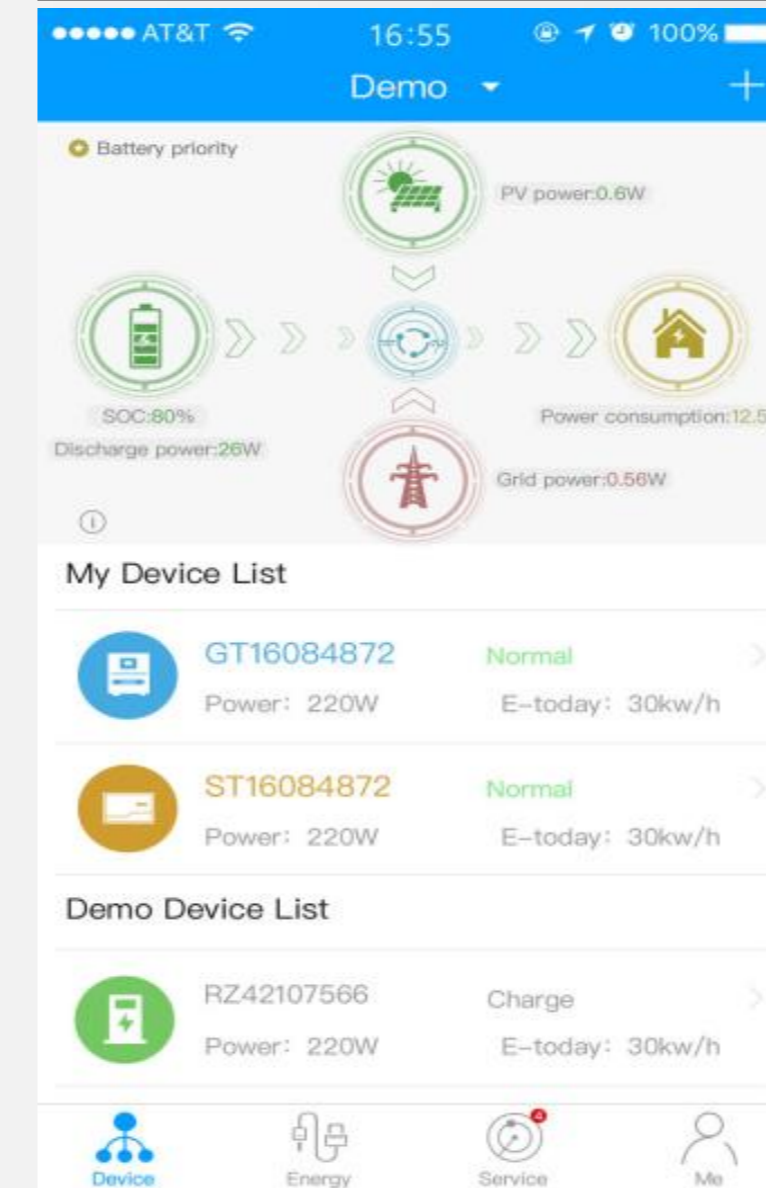

Monitoring Configuration Process

1. Scan the QR code below to download ShinePhone APP, also you can search ShinePhone in IOS or Google Play Store.

2. Open Shine Phone APP, click “Register” on login page.

3. Fill out the required information

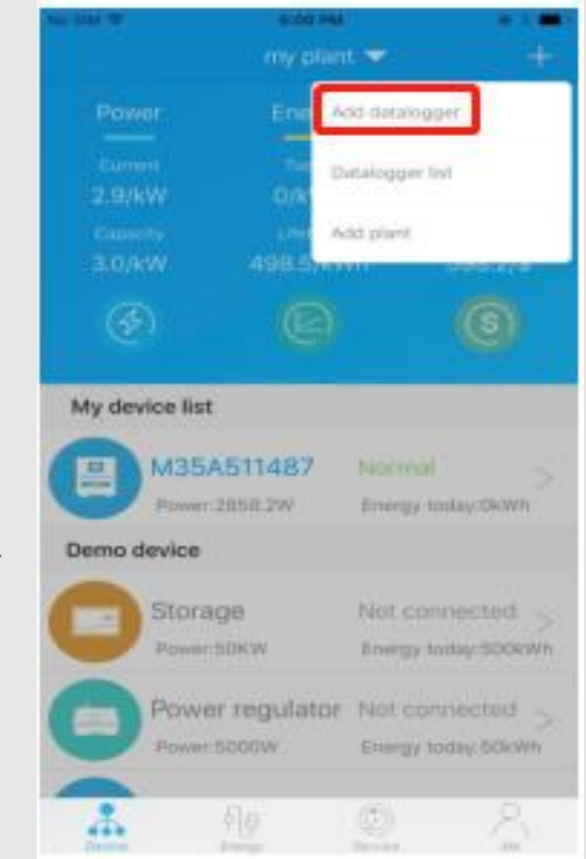
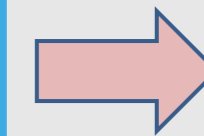
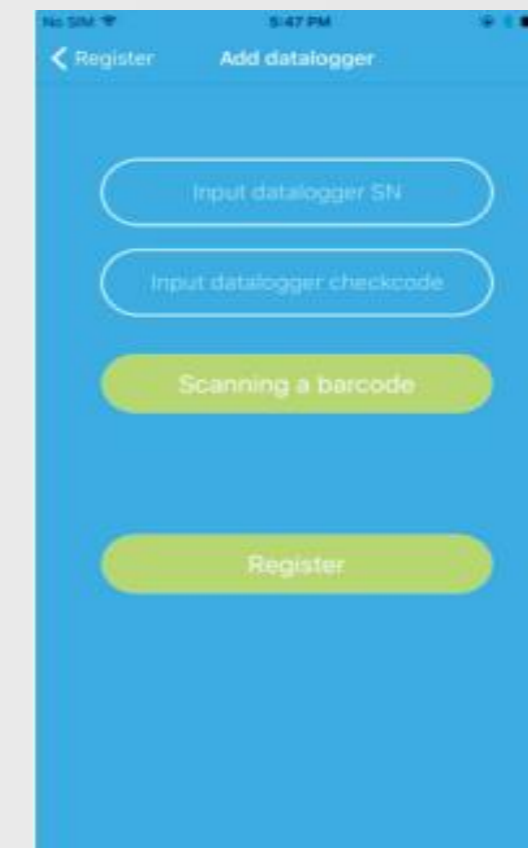
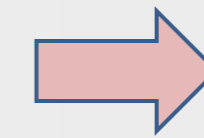
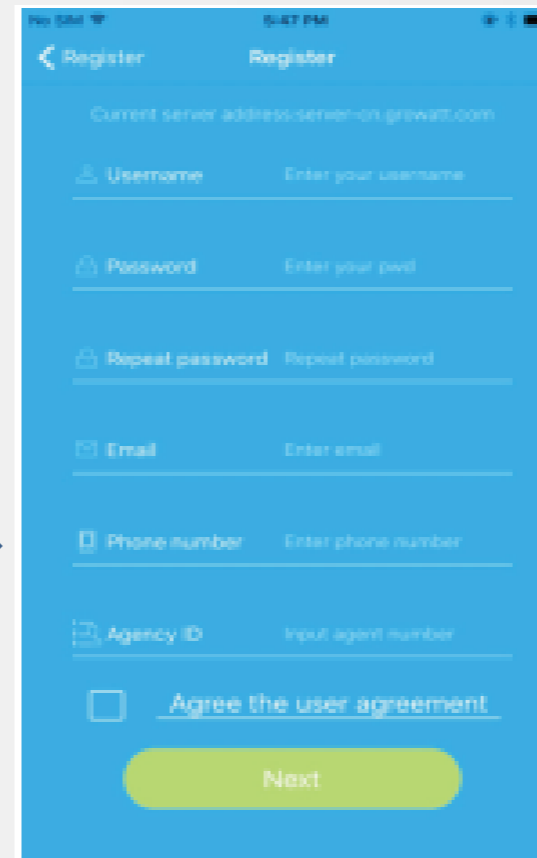
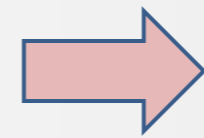
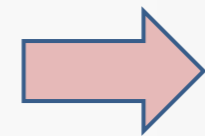

4. Click the “+” sign on the right top side “my plant” page and select “add data logger”

5. Scan or input the Shine WiFi barcode and check code.

6. Fill out the wifi network and password, then click “Configuration”

7. After successful configuration, it will move to the “my plant” page

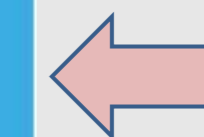
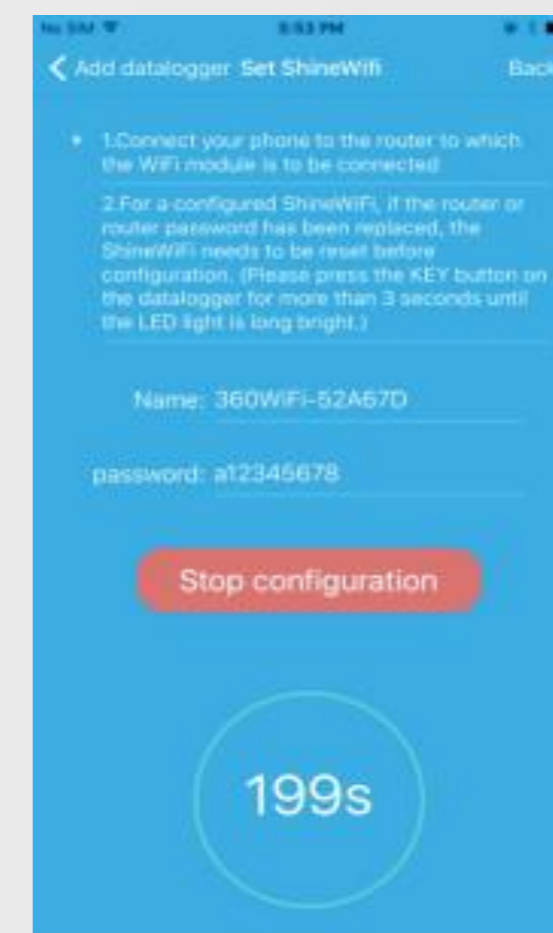
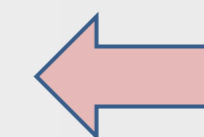
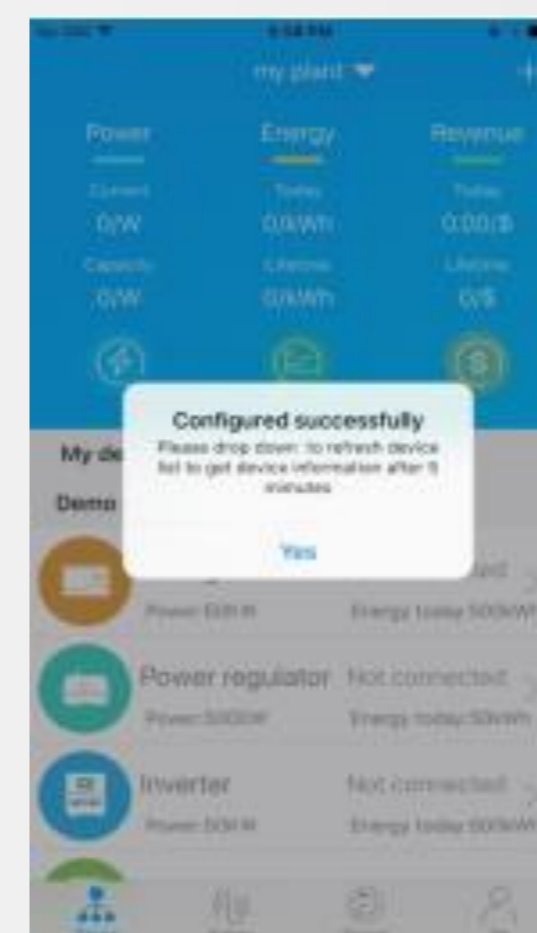
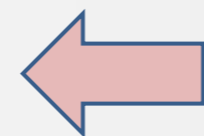
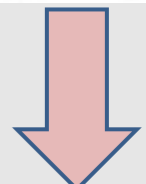

Battery Equalization

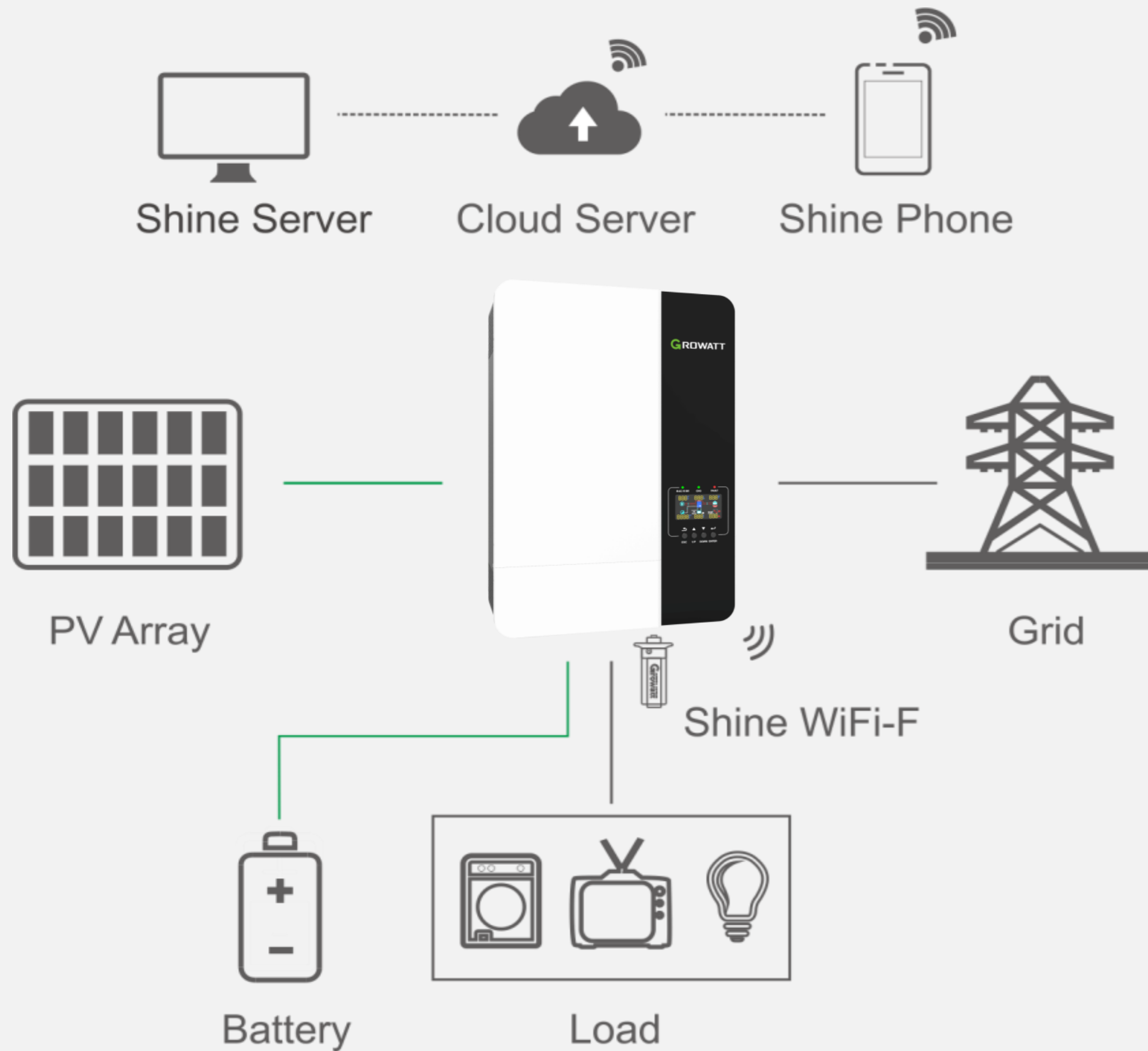

Inverter can setting lead-acid battery equalization charge interval time and charge voltage to active lead-acid battery feature then further can extend lead-acid battery life time.

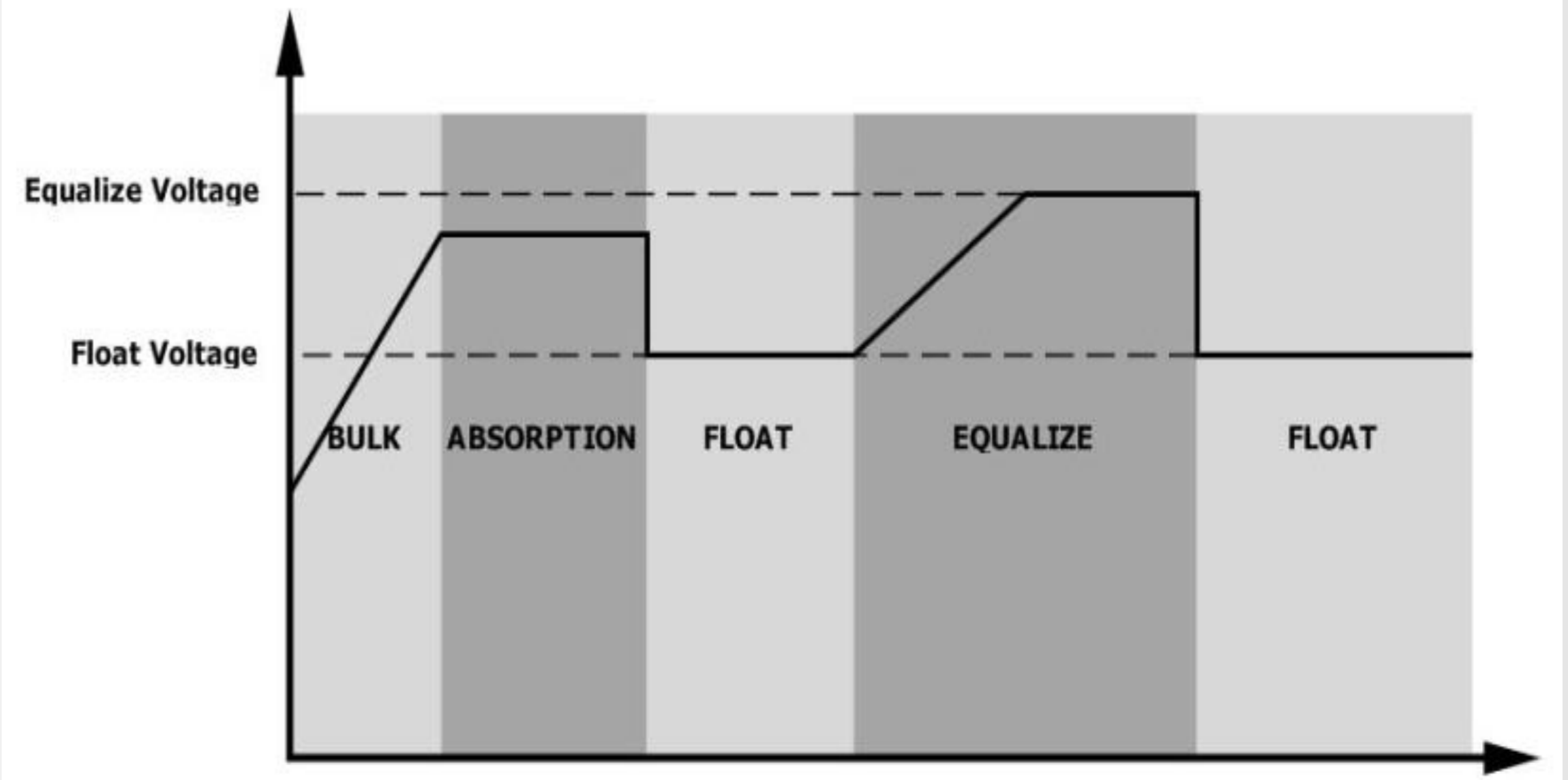

Charging curve

SUB Work Mode

If solar energy is not sufficient to power all connected loads, solar and utility will power loads at the same time

**General 5KVA inverter
(Solar power + battery power)**

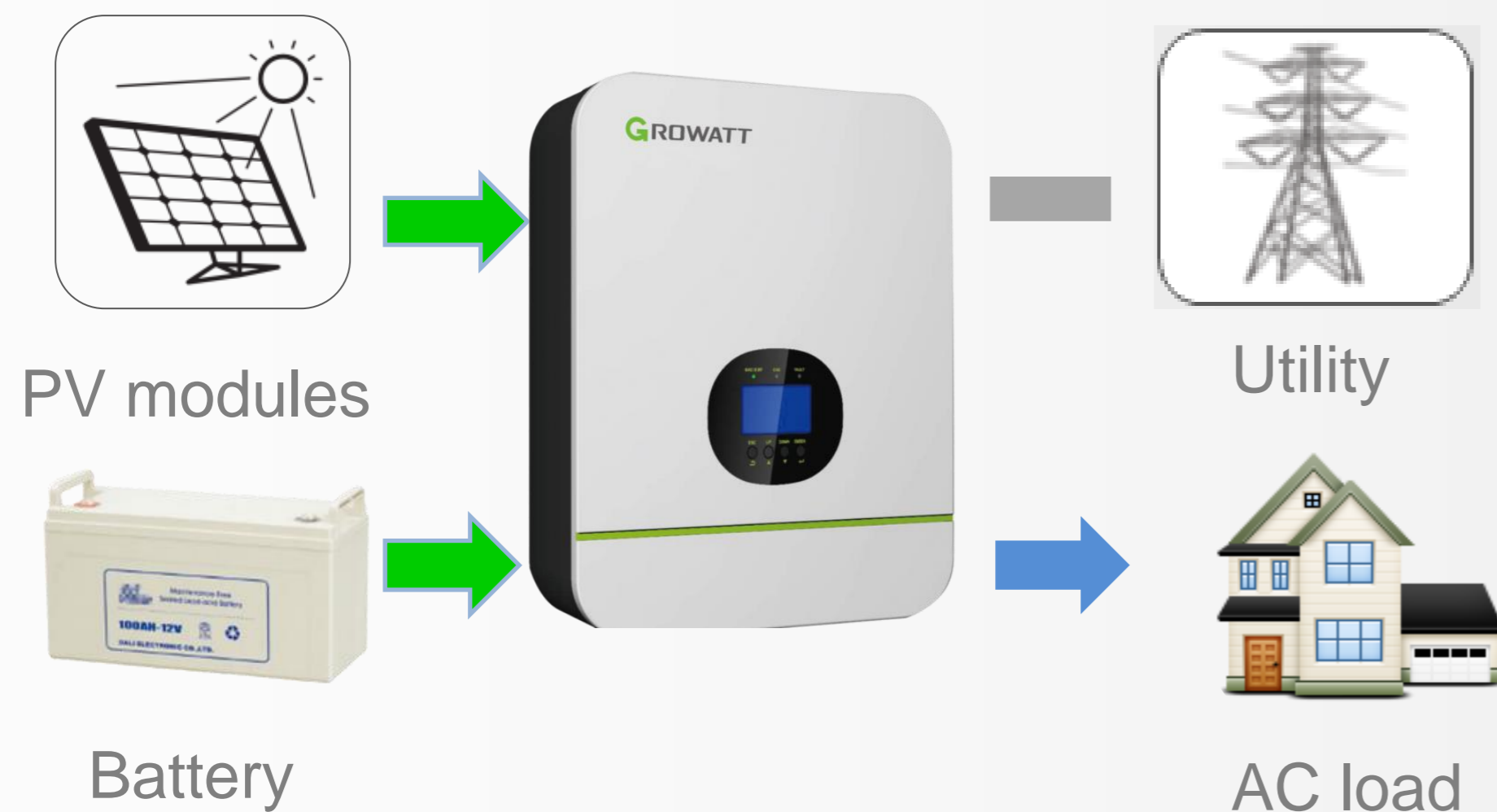

**SPF 5000ES
(Solar power + Utility power)**

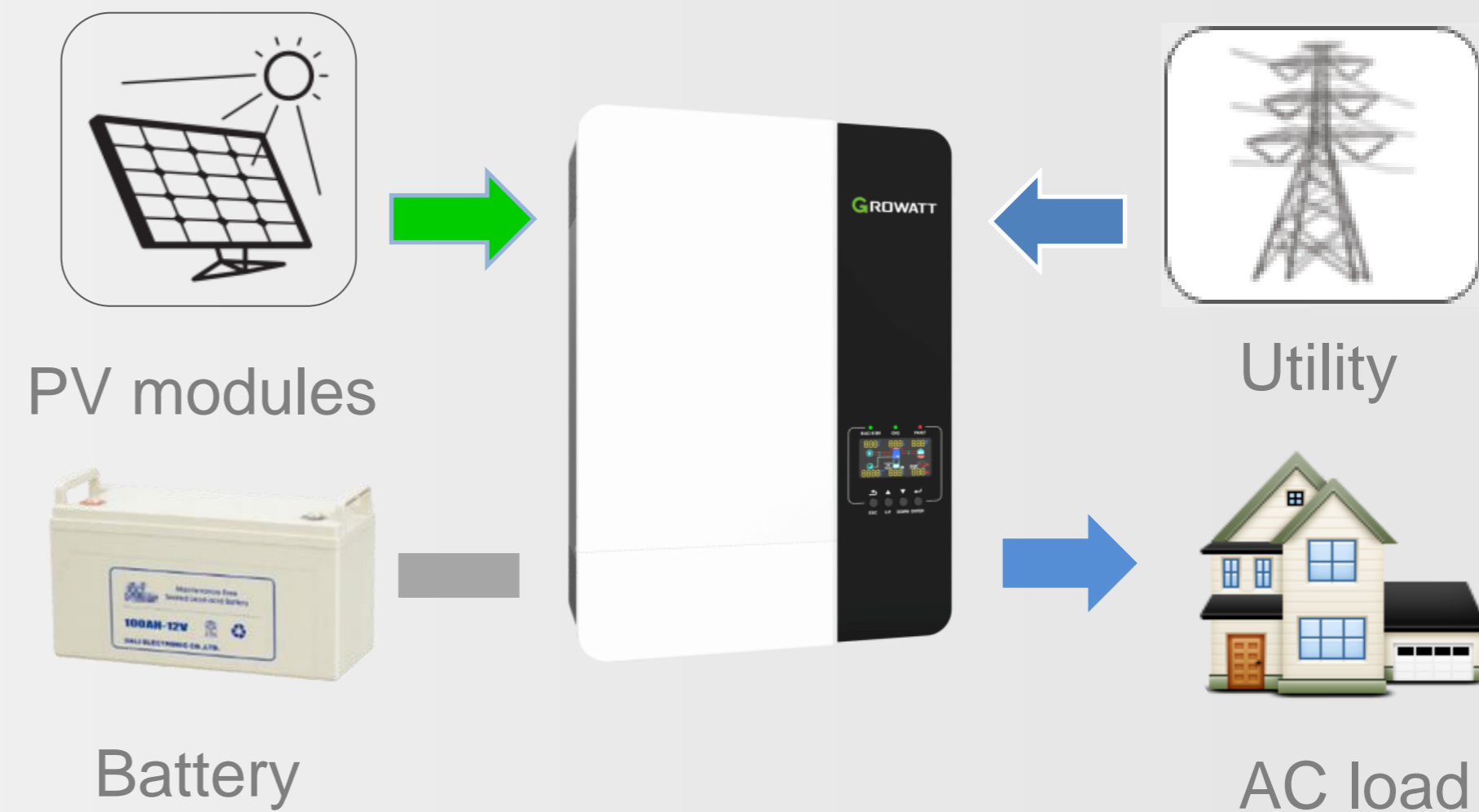

05

AXE Lithium Battery

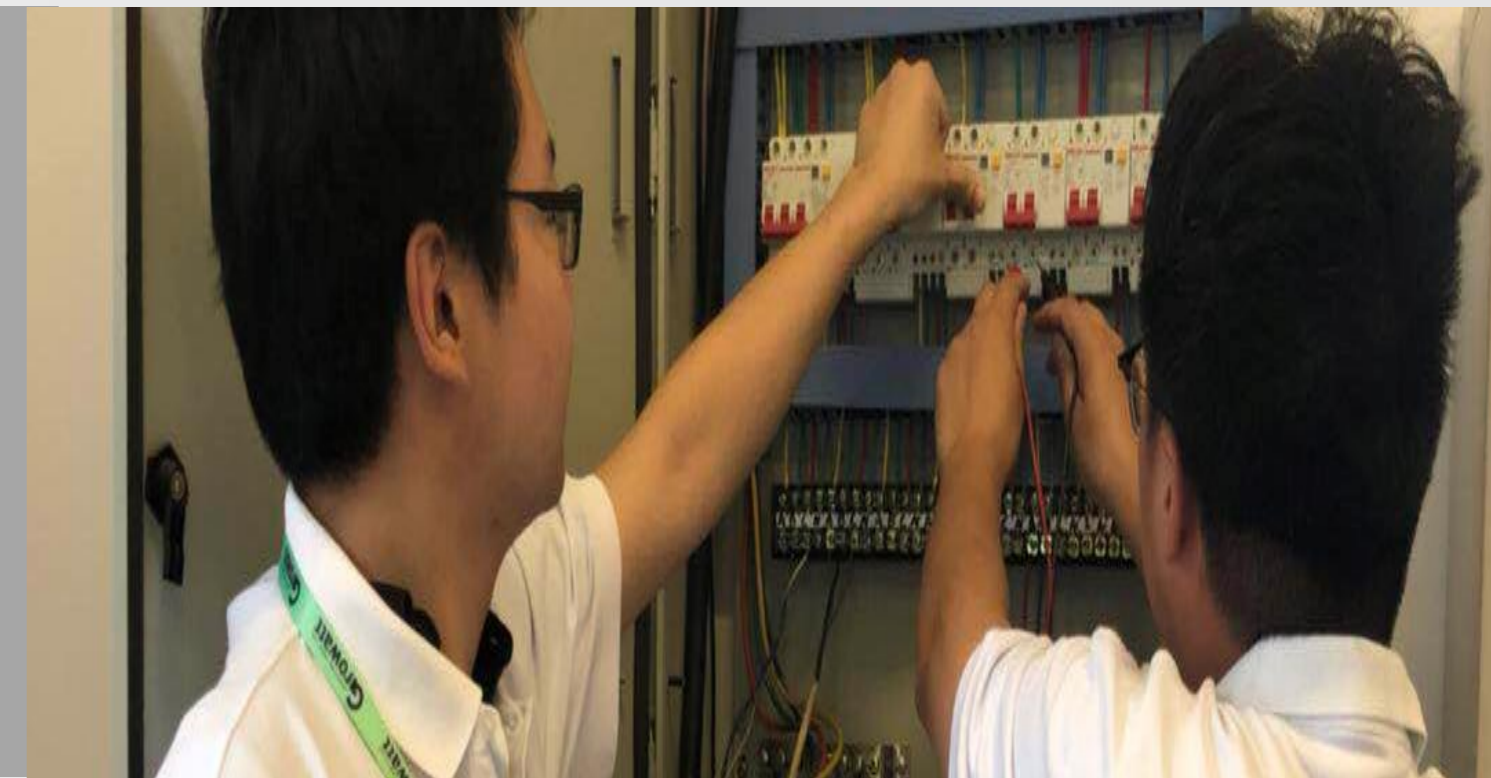

Product Overview

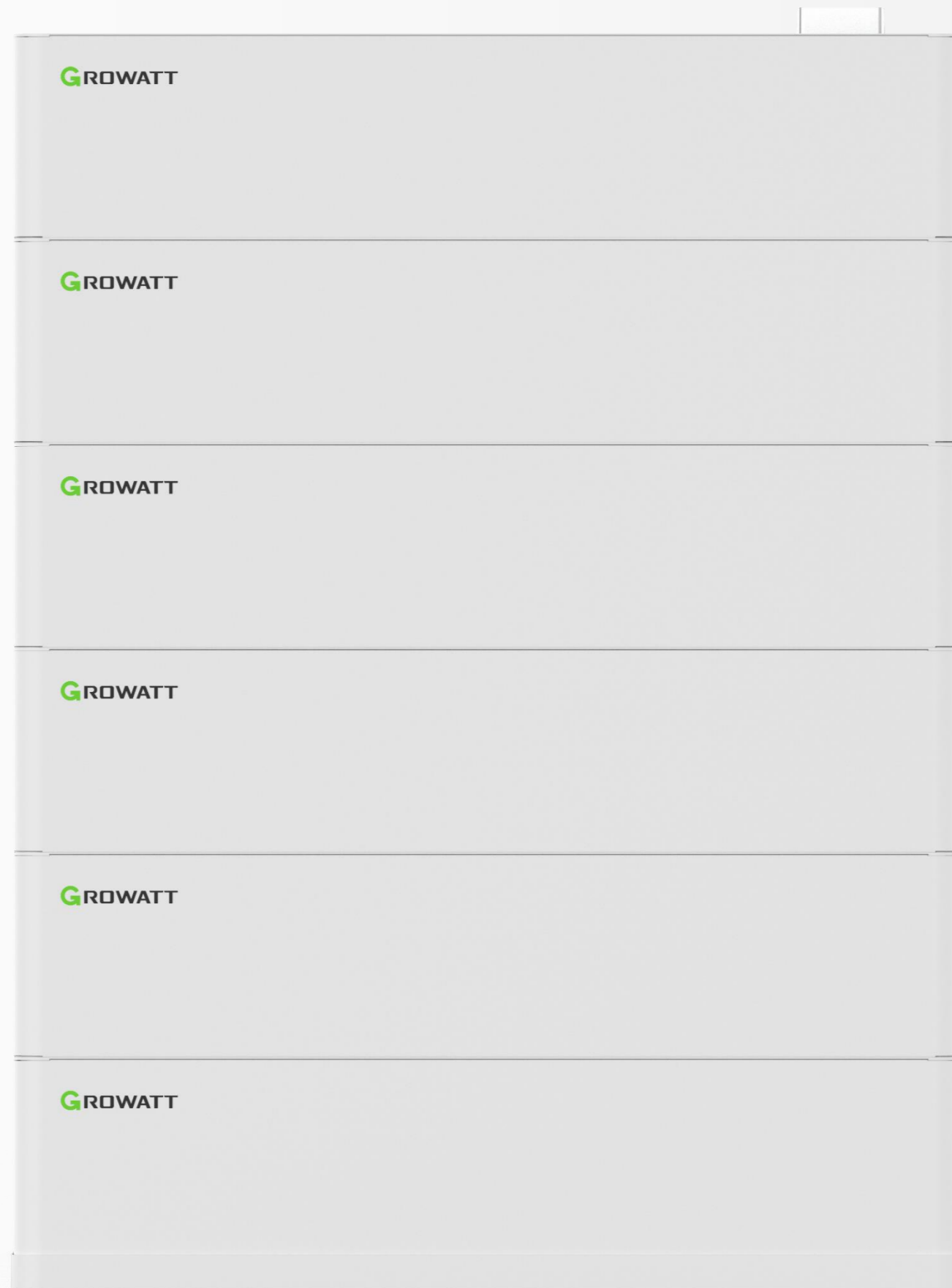

AXE Low Voltage Battery System

5.0kWh / Module

Capacity: 5.0kWh ~ 50kWh

System Flexibility

Easy installation by stacked modular design without any cable connection



Quick connection from battery system to inverter

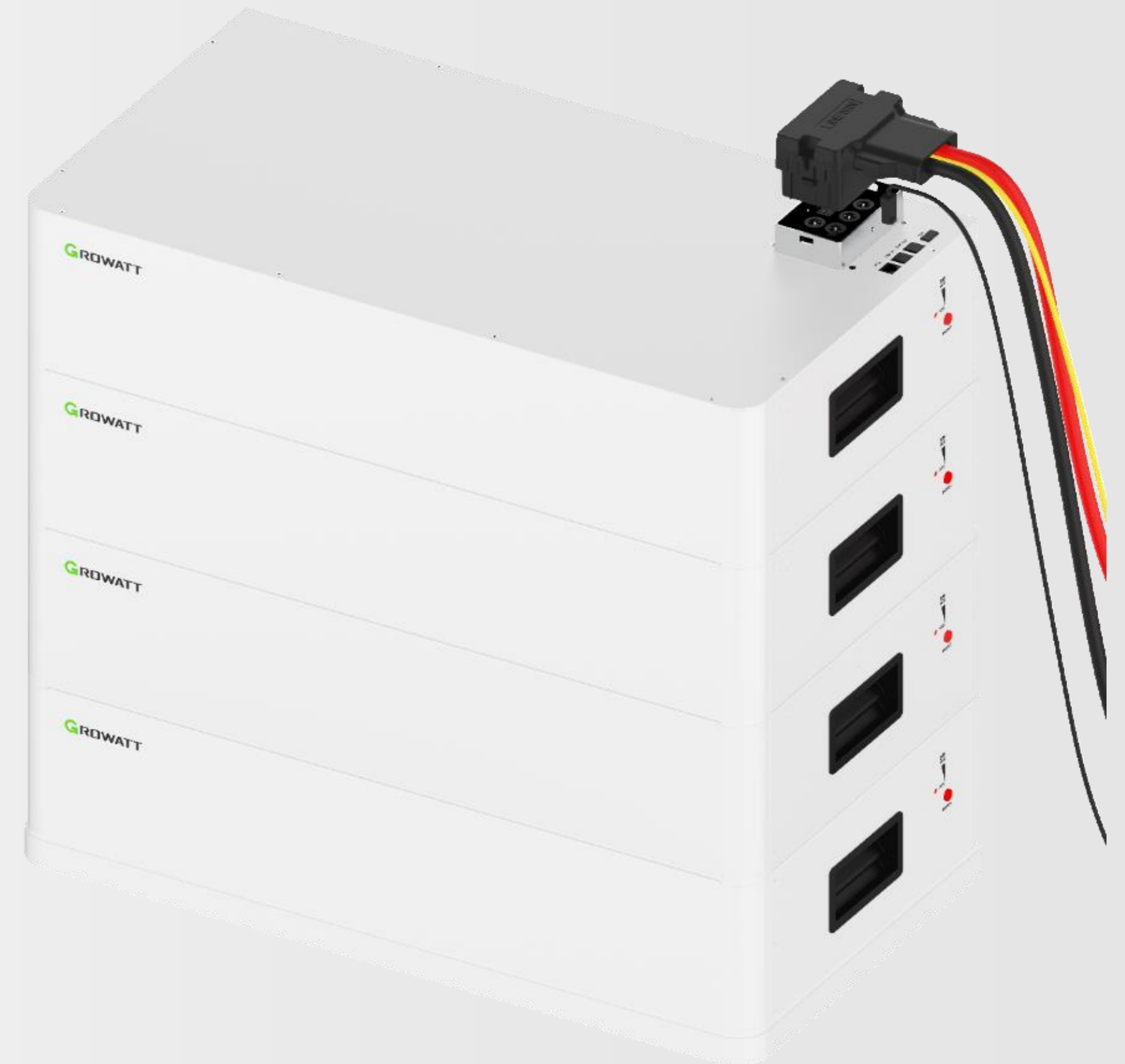

System Flexibility

Supporting max. 8 clusters in parallel reaches 400kWh

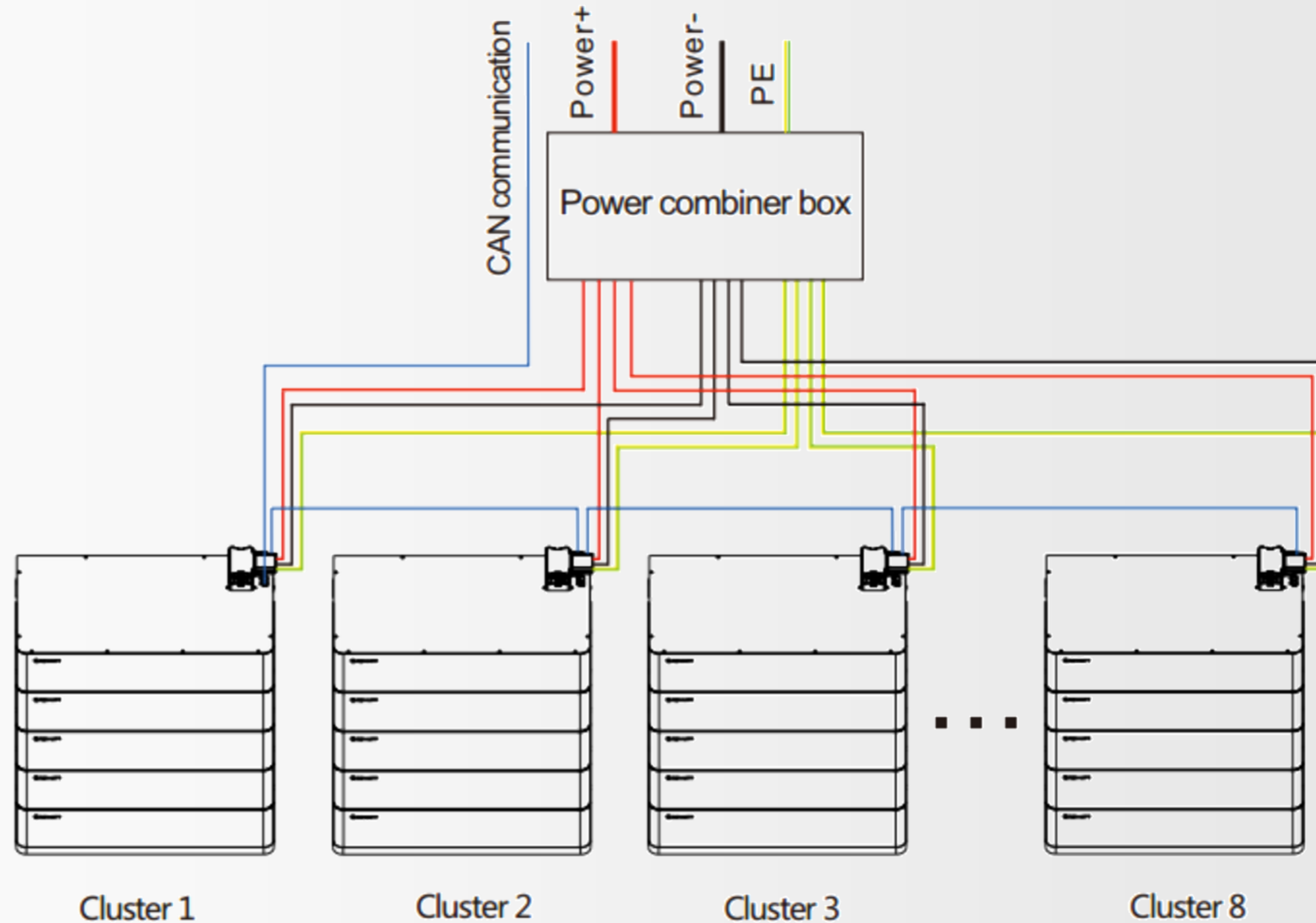

*Power combiner box need to be prepared by installer

Parameter

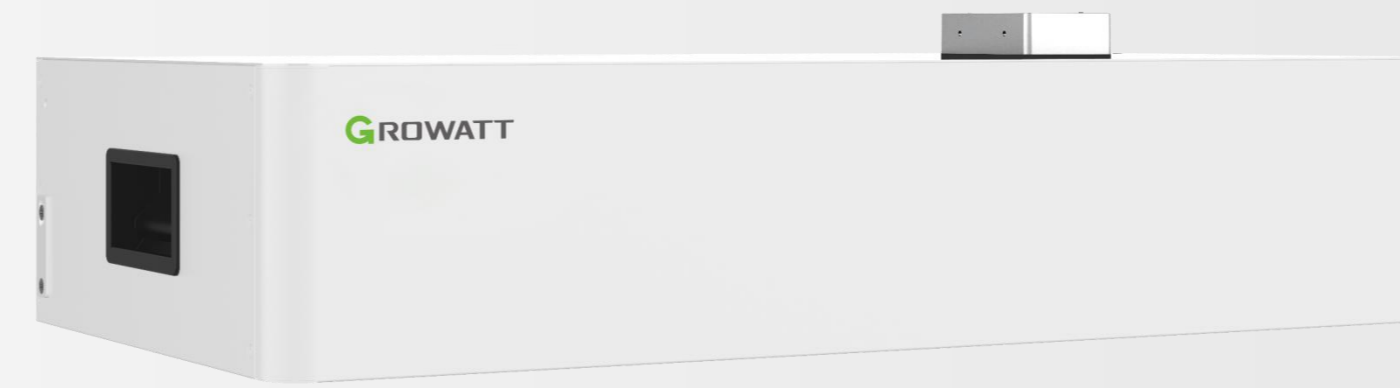

Battery System	AXE 5.0L
Total energy	5.0kWh
Battery pack connection	1 ~ 10 packs in parallel
Battery cluster connection	1 ~ 8 clusters in parallel
Nominal voltage Range	51.2V (48-57.6V)
Charging/discharging current	60A
IP degree	IP 20
Operation temperature	0 ~ 50° C
Dimension(W*D*H mm)	650*350*165
Weight	45kg
Communication	CAN/RS485
Warranty (5 Years/10 Years)	Yes/Opt

06

Application Scenarios

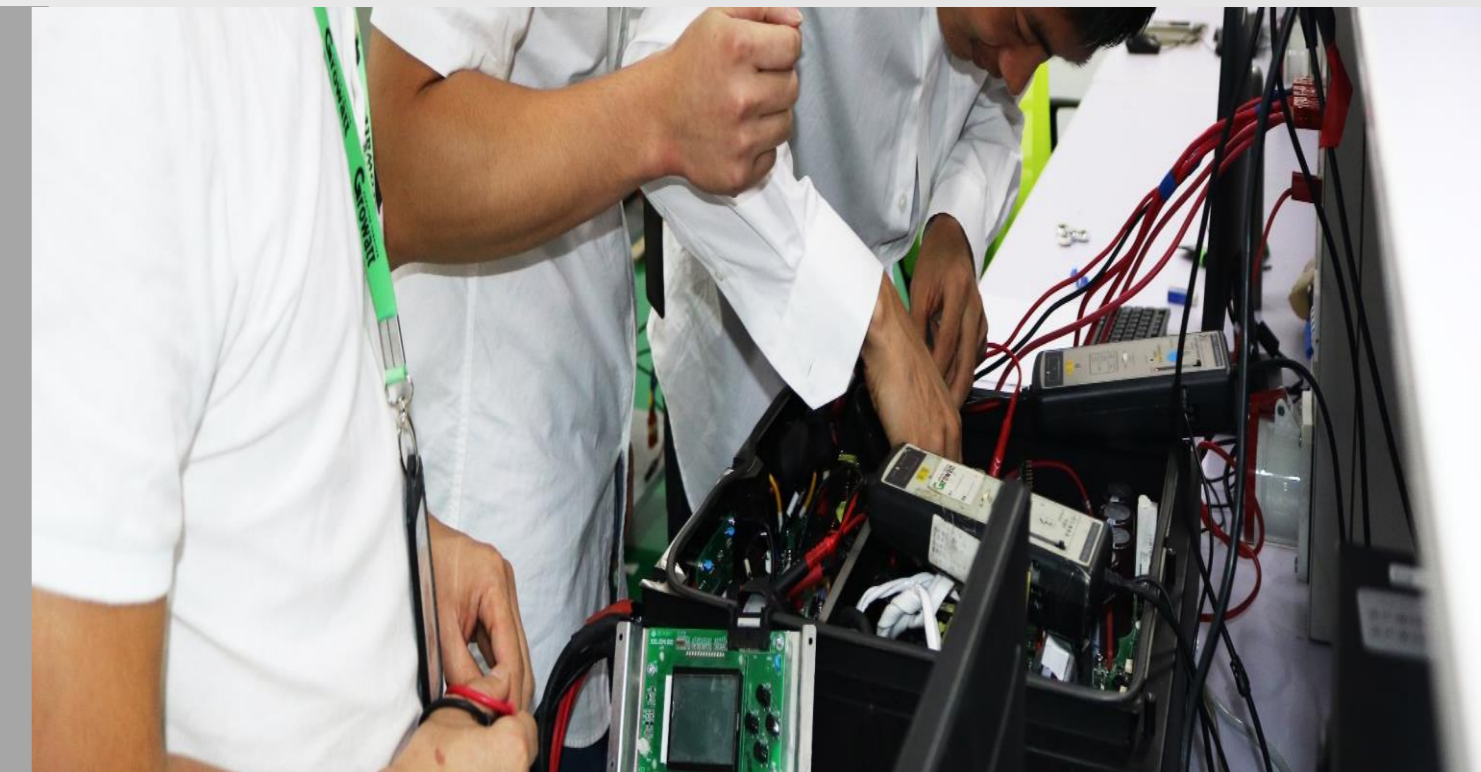

Multiple Work Modes

Working mode: (output SOL: solar first ; charging SNU: solar and utility power)

1. Solar power is sufficient



2. Solar power is not sufficient



3. Battery discharge low voltage back to utility mode (44-51.2 Vdc can set)



4. Utility charging voltage back to battery mode (48-58 Vdc can set)



Multiple Work Modes

Working mode: (output UTI: utility first ; charging SOC : solar first)

1. Solar power is sufficient



2. Solar power is not sufficient



3. Solar power is not available



4. Utility power is not available



Scenario 1: Save Electricity Cost

When Solar power is sufficient (supply power to load and charge the battery). For cost-effective support, Utility feeds power only if the battery feeding is under low-level warning value.

Solar power is sufficient



Solar power is not sufficient

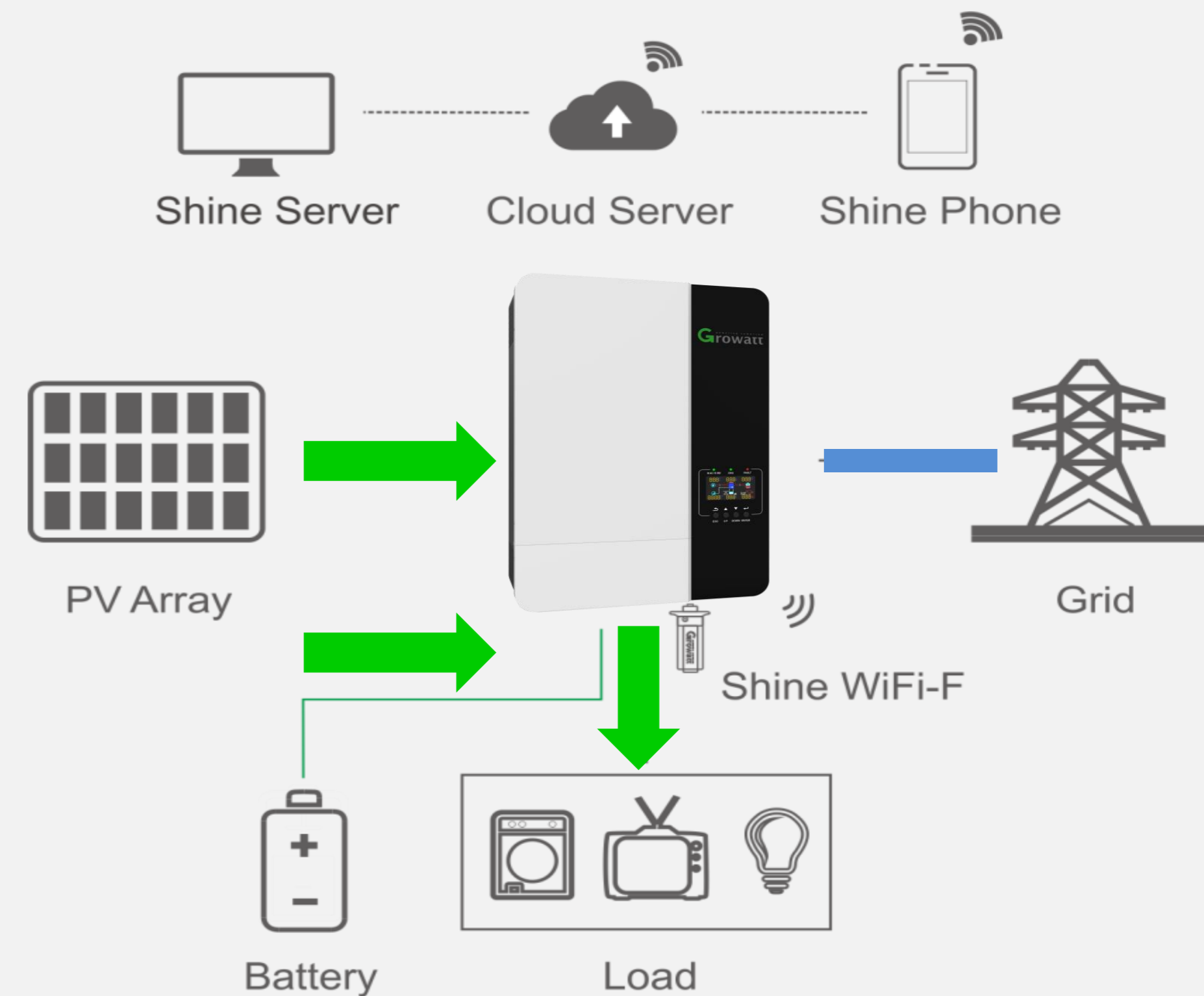

Priority mode : SBU first (other parameters use default setting)

Scenario 2: Power Backup

Solar power is sufficient (supply power to load and also charge the battery). When solar power is not sufficient, utility supply power to the load and charge the battery

Solar power is sufficient

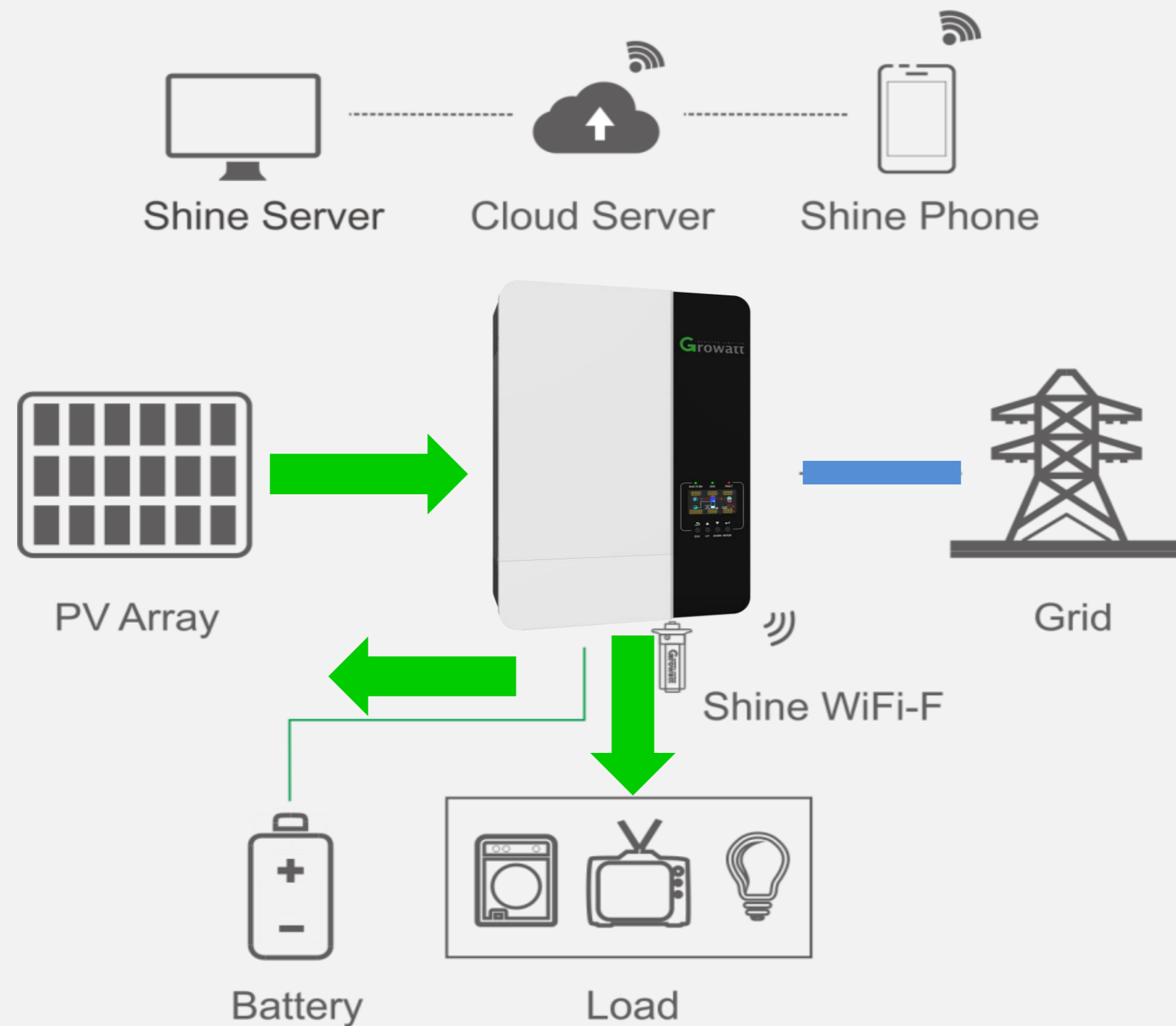

Solar power is not sufficient

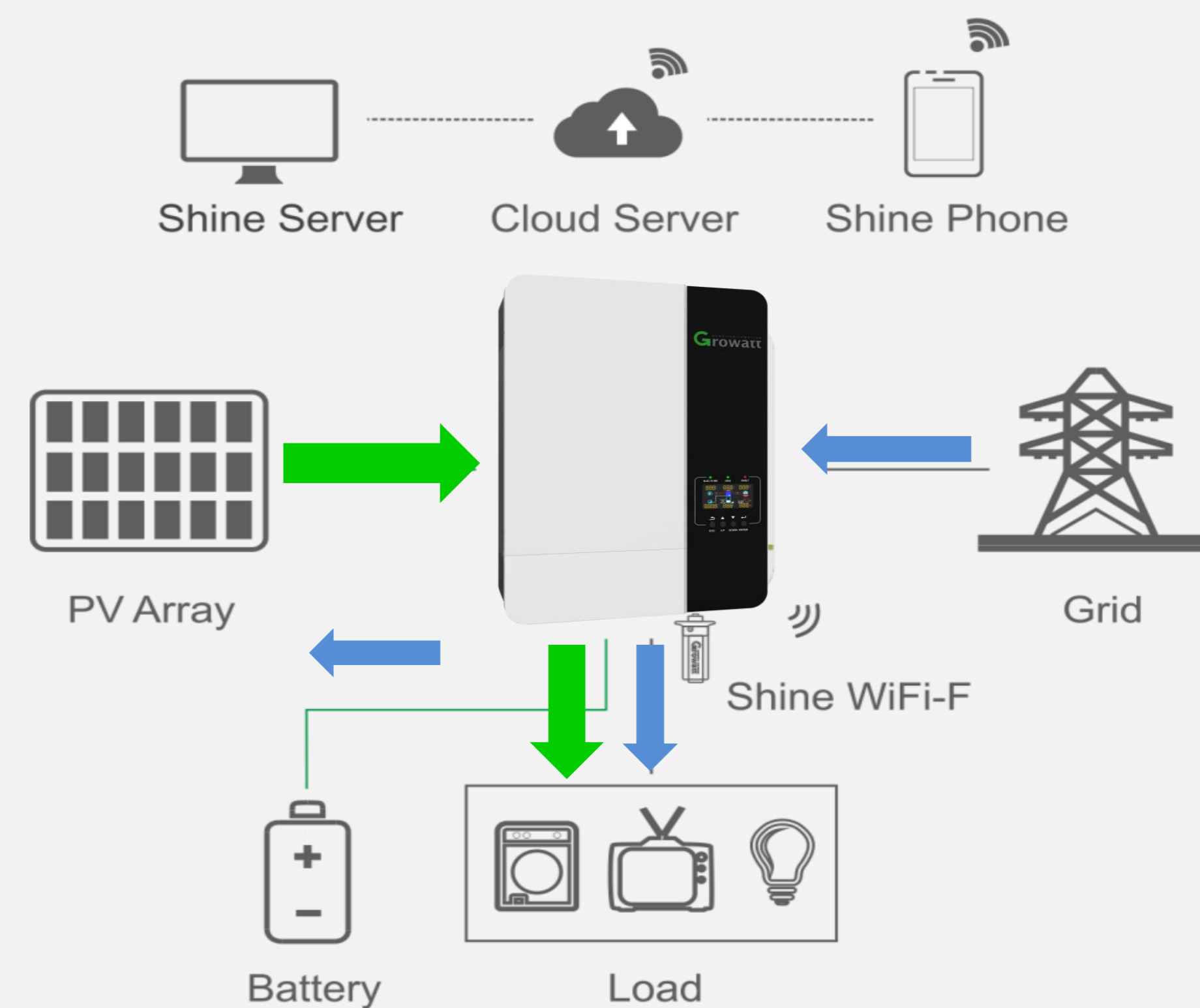

Priority mode : SUB first or SOL first

(should set battery discharge voltage higher from program 12 by LCD screen button or shine Phone APP)

Scenario 3: Off-Peak Charging

The time of grid power support and battery charging/discharging can be set during off-peak or peak time

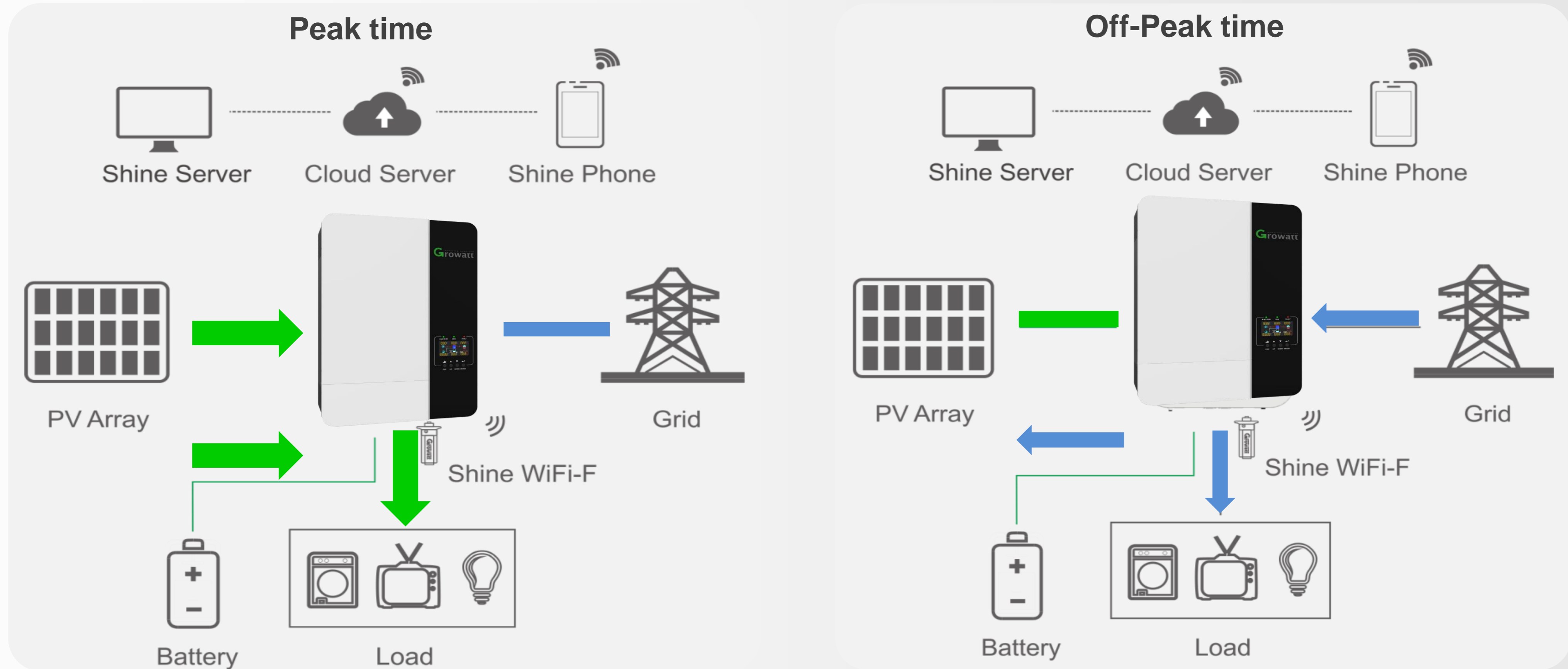

Charging time setting (suitable for all work modes)

Reference



South Africa 10kW system



Turkey 10kW system



Brazil 5kW system

Reference



South Africa 10kW system



South Africa 15kW system



South Africa 5kW system

Thanks!



Copyright© 2021 Growatt New Energy Technology CO., LTD

All Rights Reserved. The information contained in this document is only for reference purpose and subject to change by company officials.

🔍 Growatt New Energy

