

Hisense



UEFA  
EURO2024  
GERMANY

OFFICIAL PARTNER

# HISENSE CATALOGUE

# BEYOND

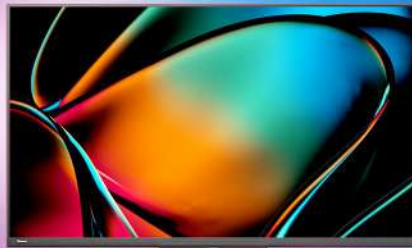

Laser TV • TV • Refrigeration • Laundry • Kitchen Appliances • Air Conditioning

# Content

|                                      |    |
|--------------------------------------|----|
| ● Reliable Hisense .....             | 01 |
| ● TV .....                           | 03 |
| ● Laser TV .....                     | 15 |
| ● AUDIO .....                        | 25 |
| ● REFRIGERATION<br>and Freezer ..... | 34 |
| ● WASHING MACHINE .....              | 53 |
| ● MICROWAVE OVEN .....               | 72 |
| ● AIR FRYER .....                    | 77 |
| ● AIR CONDITIONER .....              | 80 |

# Reliable Hisense

As a group established in 1969  
Hisense is ranked global **No.2** in TV industry



T10 ULED X  
CES 2023  
Innovation  
Award Product

2023



Triple Washer  
IFA Product Technica

2020



100L5 Laser TV  
CES 2020  
TOP PICK Award

2020

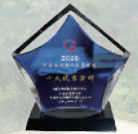

Annual Top 10 Case  
Award of 2020  
Chinese Enterprise  
Global Image

2020



Won 6 times of  
Best Global Image  
Award

2015-2020



U9 ULED TV  
Annual Display  
Technology Innovation

2018



Triple Washer  
IFA Product  
Technica

2018



4k Laser TV  
Annual Golden  
Award

2017



Top 10  
International  
Influence Enterprises

2016



BrandZ Top 100  
Most Valuable  
Chinese Brands

2014

# Global Network

Hisense's global industrial parks,R&D centers,and overseas companies

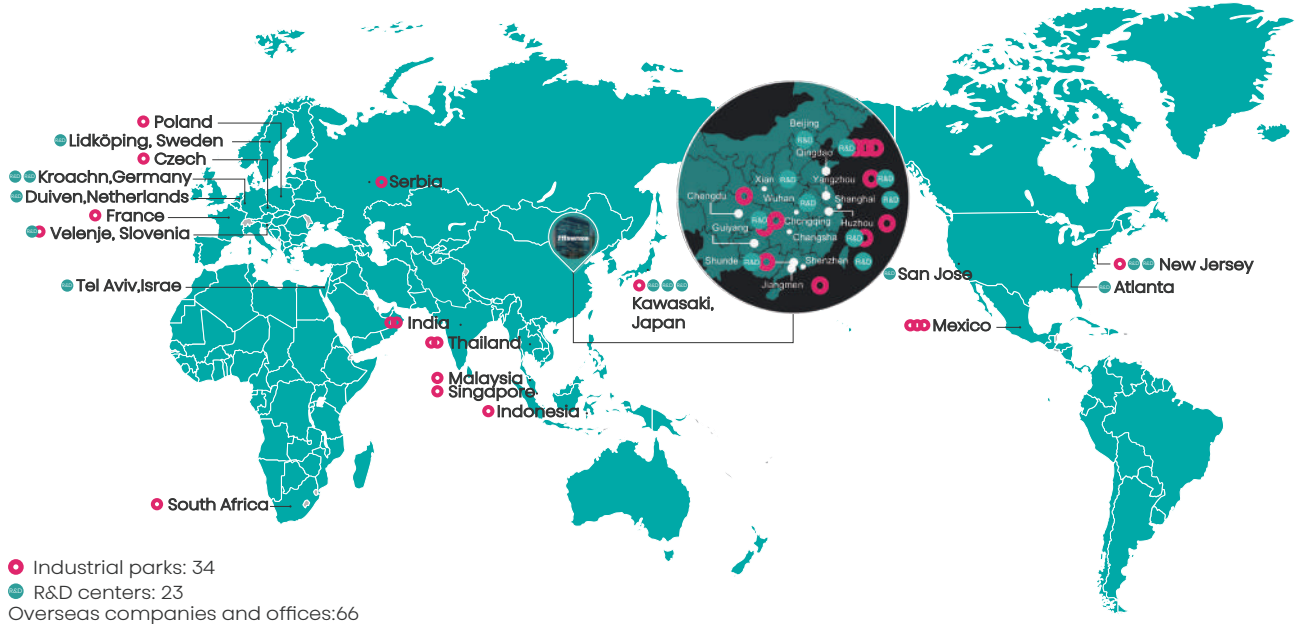

QingDao · China



Colors · Nigeria

## Hisense Profile

Hisense was founded in 1969. At present, Hisense owns four listed companies—Hisense Visual Technology (600060), Hisense Home Appliances (000921), SANDEN (6444) and CHANGELIGHT (300102) listed in Shanghai, Shenzhen, Hong Kong and Tokyo. And it also owns many brands including Hisense, Toshiba TV, Ronshen, gorenje, and ASKO. In 2022, Hisense maintained sound growth. The total operating revenue of Hisense group was CNY 184.9 billion and the total profits reached CNY 12.3 billion, increased by 21%. The overseas income reached CNY 75.7 billion. The Hisense International Brand accounted for more than 83%.

According to the Top 50 Kantar BrandZ Chinese Global Brand Builders 2022 launched by Google and Kantar, Hisense was one of the "Top Ten most familiar Chinese brands to overseas citizens" for seven consecutive years. With the products exported to over 160 countries and regions, Hisense has sponsored the world's top sporting events such as UEFA EURO 2016, FIFA World Cup 2018, UEFA EURO 2020, and FIFA World Cup 2022, also became the official partner of Paris Saint-Germain football club. What's more, Hisense is the first batch of innovative enterprises in China and has won the "National Quality Award" twice. Hisense has 23 industrial parks located in Qingdao, Shunde, Huzhou, Czech Republic, South Africa, Mexico, etc. There are also 23 R&D centers located in Qingdao, Shenzhen, the USA, Germany, etc. There are more than 10,000 engineering and technical personnel, and 8,000 masters and doctors, with which Hisense initially established a global collaborative R&D system.

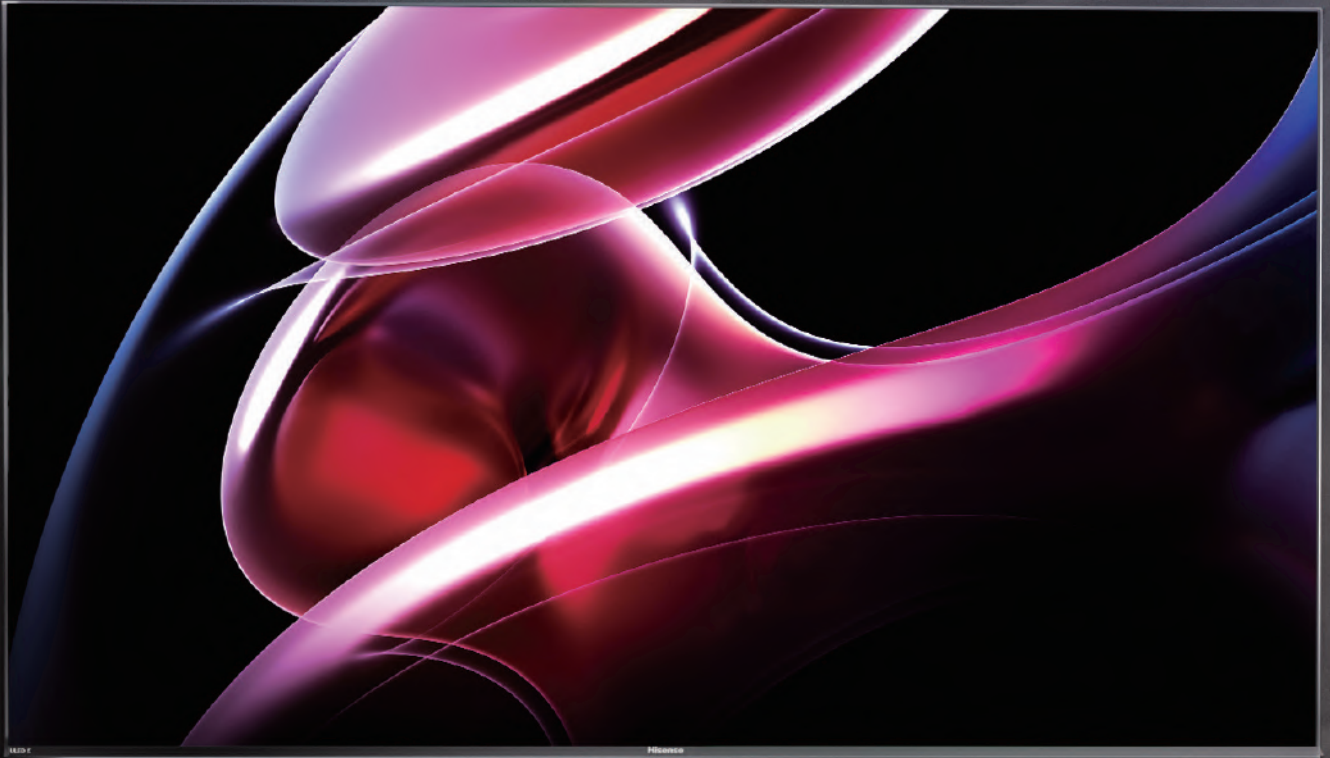

**TV**

COLLECTION

2023 - 2024



# Mini-LED ULED 4K

---

## Lighting the way forward

Hisense has always been at the forefront of home entertainment, driving advancements in LED technology to enhance every aspect of the viewing experience. The new Hisense Mini-LED ULED TV range represents the next step forward with Mini-LED backlight innovation, Hi-View Engine and Quantum Dot Colour. We are lighting the way to ultimate picture quality, creating a world of entertainment that's brighter, more immersive, and more captivating than ever before.

# UX Mini-LED ULED X

85"

75"



## Marks the spot



"X" is usually used as a position mark on a treasure map. Find X, get precious deposits. UX Series is such a treasure of ULED category. X also refers to 10-year R&D of ULED, which is driven by the pursuit of ultimate picture quality. It's equipped with the most advanced Mini-LED TV technologies to guarantee premium PQ performance in all conditions, regardless content and ambient. Everything which can contribute to picture and audio is considered. In addition, it's not only a stack of fine spec. Hi-View Engine X composes a fabulous image with supporting of hardware, and brings the audio-visual feast to end-users.

### 1 TV shows

- Mini-LED X
- Hi-View Engine X
- Dynamic X-Display
- 2,000+ nits Peak Brightness\*
- Quantum Dot Colour
- Dolby Vision IQ

### 2 Blockbusters

- CineStage X Surround (4.1.2)
- IMAX® Enhanced
- FILMMAKER MODE™
- WISA Ready
- Dolby Atmos®

### 3 Sports

- 120Hz Ultra Motion
- AI Sports Mode

### 4 Gaming

- AMD Freesync Premium
- 144Hz Game Mode Pro
- Gaming in Dolby

### 5 Smart control

- VIDAA SMARTS OS
- Works with AirPlay®
- Works with Apple Home™
- Hands-Free Voice Control

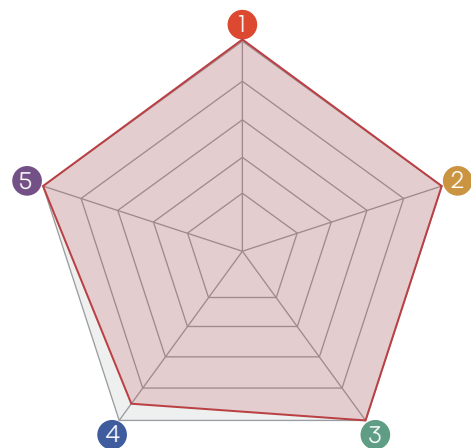

\*2,000+nits Peak Brightness on 85" model

# U8K Mini-LED ULED 4K

65"



## Beyond the extraordinary



Movies. Games. TV. The U8K Series shows it all in glorious detail. Bringing stunning pictures and incredible sound through game-changing technology. From the cutting-edge Mini-LED Pro to the immersive Dolby Atmos audio. Settle in for a truly cinematic experience. And with the 60° viewing angle, you'll always have the best seat in the house. The U8K takes your gaming and sports to the next level too. With 120Hz Ultra Motion Mode and Sports Mode ensuring the action is always crystal-clear.

### 1 TV shows

- Mini-LED PRO
- Hi-View Engine
- Quantum Dot Colour
- Total HDR Solution

### 2 Blockbusters

- Multi-Channel Surround (2.1.2)
- IMAX® Enhanced
- FILMMAKER MODE™
- WiSA Ready
- Dolby Atmos®

### 3 Sports

- 120Hz Ultra Motion
- AI Sports Mode

### 4 Gaming

- AMD Freesync Premium
- 144Hz Game Mode Pro
- Gaming in Dolby
- 240 High Refresh Rate

### 5 Smart control

- VIDAA Smart OS
- Works with AirPlay®
- Works with Apple Home™
- Hands-Free Voice Control

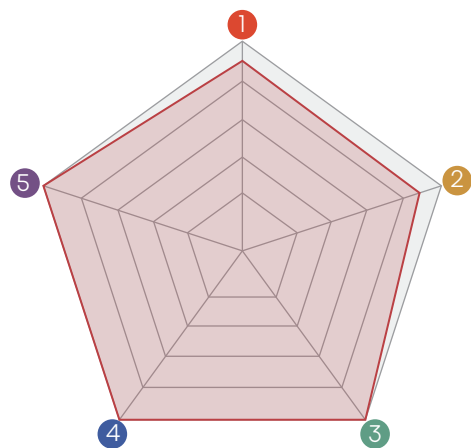



# U7K Mini-LED ULED 4K

65"



## Step up your game



Welcome to the next level. The U7K Series. Built to give your gaming the edge. With 120Hz Ultra Motion and Game Mode Pro, you'll be able to grab incredible wins in style. No more input lag or frame tearing getting in the way. The Mini-LED delivers brighter, clearer pictures with an even greater level of detail than normal LED. And with Room-Fitting Sound, every explosion or rev of the engine will fill the space. Making your gameplay, films, and shows look and sound incredible at the same time.

### 1 TV shows

- Mini-LED
- Hi-View Engine
- Quantum Dot Colour
- 1,000+ nits Peak Brightness
- Total HDR Solution

### 2 Blockbusters

- FILMMAKER MODE™
- Dolby Atmos®

### 3 Sports

- 120Hz Ultra Motion
- AI Sports Mode

### 4 Gaming

- AMD Freesync Premium
- 144Hz Game Mode Pro
- Gaming in Dolby
- Game Bar
- 240 High Freash Rate

### 5 Smart control

- VIDAA Smart OS
- Works with AirPlay®
- Works with Apple Home™
- Hands-Free Voice Control

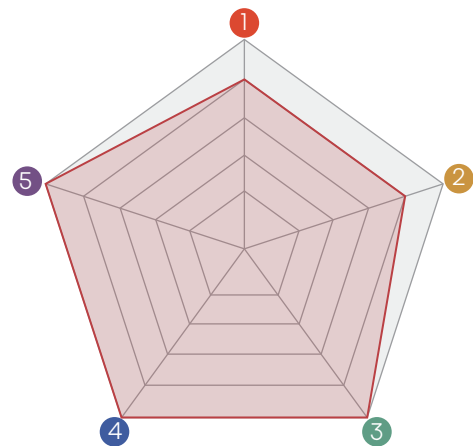

# U6K Pro Mini-LED ULED 4K

75" 65" 55"

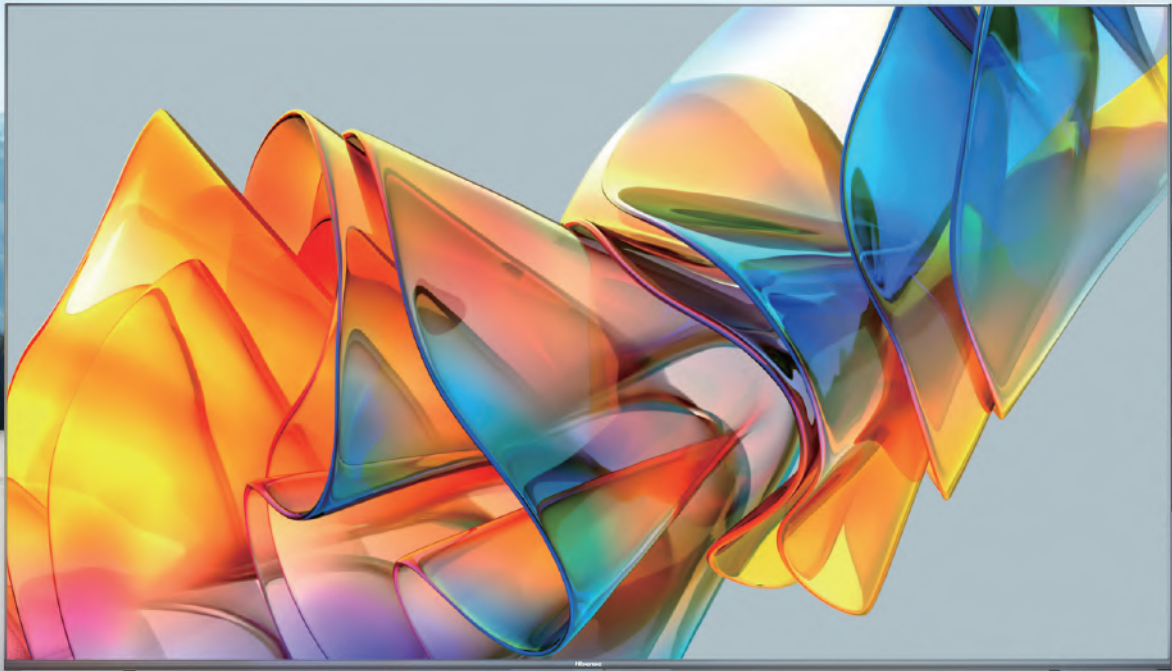

## Shine brighter with Mini-LED



U6K Pro Series is the one you need to know about. Changing the way you watch and game with Mini-LED technology. Coupled with Quantum Dot Colour, bringing over a billion colours, you'll see details you've never seen before. Dolby Vision and Dolby Atmos brings a state-of-the-art audio and video experience that puts you in the middle of the action. No 4K content? No worries. The 4K AI Upscaler upgrades 2K images to 4K automatically. It's time to discover the power of the U6K Pro Series.

### 1 TV shows

- Mini-LED
- Quantum Dot Colour
- Hi-View Engine
- 4K AI Upscaler
- Adaptive Light Sensor
- Total HDR Solution

### 2 Blockbusters

- Dolby Atmos®
- EZPlay
- eARC

### 3 Sports

- AI Sports Mode
- Smooth Motion

### 4 Gaming

- Game Mode Plus
- 120 High Refresh Rate

### 5 Smart control

- VIDAA Smart OS
- VIDAA Voice
- Works with AirPlay®
- Works with Apple Home™

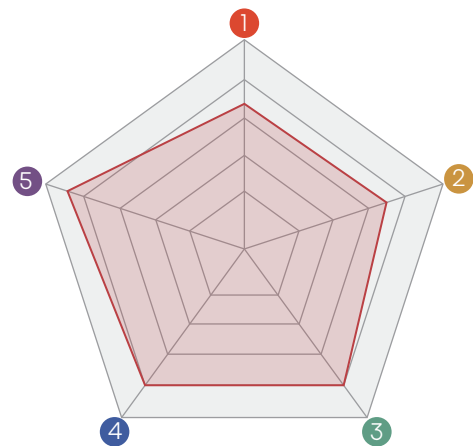

# U6K ULED 4K

65" 55"



## Brighter.Smarter.Faster



U6K Series is the one you need to know about. Changing the way you watch and game with Hi-View Engine technology. Coupled with Quantum Dot Colour, bringing over a billion colours, you'll see details you've never seen before. Dolby Vision and Dolby Atmos brings a state-of-the-art audio and video experience that puts you in the middle of the action. No 4K content? No worries. The 4K AI Upscaler upgrades 2K images to 4K automatically. It's time to discover the power of the U6K Series.

### 1 TV shows

- Quantum Dot Colour
- Hi-View Engine
- 4K AI Upscaler
- Total HDR Solution

### 2 Blockbusters

- Dolby Atmos®
- EZPlay
- eARC

### 3 Sports

- AI Sports Mode
- Smooth Motion

### 4 Gaming

- Game Mode Plus
- 120 High Refresh Rate

### 5 Smart control

- VIDAA Smart OS
- VIDAA Voice
- Works with AirPlay®
- Works with Apple Home™

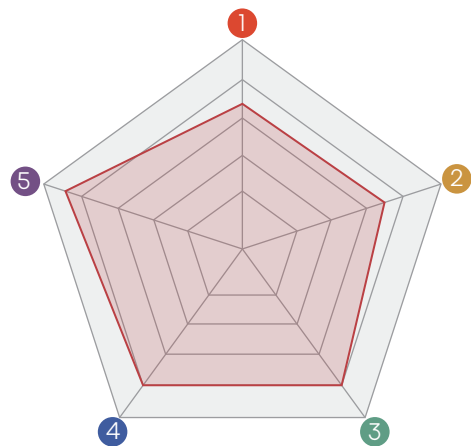

# A7K UHD4K

85" 75" 65" 55"



## Flowing colours, dazzling views

Enjoy over a billion shades of colours display via Hisense A7K UHD 4K Smart TV which is loaded with Wide Colour Gamut. Dolby Atmos® enabled TV brings breakthrough immersive audio experience to your home. Game Mode Plus with ALLM and VRR 60Hz will give you the ultimate gaming experience. 4K HDR Certified resolution delivers breath-taking picture quality, advanced real-time AI scene optimization. Bring the true cinematic experience home with support for all the latest HDR formats of HDR10, Dolby Vision™. Hisense's new VIDAA Smart TV OS lets you enjoy all your favourite entertainment from Netflix, Disney+, Prime Video, and YouTube.

### 1 TV shows

- Wide Colour Gamut
- 4K AI Up scaler
- Dobby Vision
- Pixel Tunning

### 2 Blockbusters

- Dolby Atmos®
- EZ play
- eARC

### 3 Sports

- AI Sports Mode
- Smooth Motion

### 4 Gaming

- Game Mode Plus (with VRR ALLM)

### 5 Smart control

- VIDAA Smart OS
- VIDAA Voice
- Works with AirPlay®
- Voice Remote



# A6K UHD 4K

70" 65" 58" 55" 50"



## Super effective 4K choice

4K Ultra HD offers 4x more pixels than Full HD whilst HDR makes blacks darker, whites brighter and enhances contrast. DTS Virtual: X™ automatically separates out dialogue from background noise for a clearer, multi-dimensional audio experience. For the Gamer we have Auto Low Latency Mode (ALLM) which ensures smooth, lag-free and uninterrupted viewing and interaction. AI Sports Mode will give you a smooth viewing experience. At the same time, you can control your TV using VIDAA Voice.

### 1 TV shows

- 4K AI Upscaler
- Pixel Tuning
- Dolby Vision®
- AI Picture

### 2 Blockbusters

- DTS® Virtual:X™
- EZ play
- eARC

### 3 Sports

- AI Sports Mode

### 4 Gaming

- Game Mode Plus (with VRR ALLM)

### 5 Smart control

- VIDAA Smart OS
- VIDAA Voice
- Works with AirPlay®
- Voice Remote



# A4K SMART TV

43" 40" 32"



## Stream what you love

The A4K comes loaded with more smart features than some would expect in such a compact TV. Along with its Full High Definition Resolution, the TV offers a sharper, more colourful picture. Rich entertainment content can be found in the VIDAA smart OS for daily streaming. And the Game Mode and AI Sports Mode can adjust the TV settings for the optimal viewing experience when playing the latest fast-paced games or watching fast-action sports content. A4K is also equipped with HDMI ports, USB slots and Wi-Fi, you can connect more devices and external sources to your TV.

### 1 TV shows

- FHD Resolution\*
- Natural Colour Enhancer
- High Contrast
- Noise Reduction

### 2 Blockbusters

- DTS® Virtual:X™

### 3 Sports

- AI Sports Mode

### 4 Gaming

- Game Mode

### 5 Smart control

- VIDAA Smart OS

# VIDAA

It's all about 

\*FHD Resolution on 43" and 40" models.

# LED TV Specifications

|                        | Mini-LED <b>ULED X</b>                | Mini-LED <b>ULED 4K</b>    | Mini-LED <b>ULED 4K</b>    | Mini-LED <b>ULED 4K</b>  | <b>ULED 4K</b>           |
|------------------------|---------------------------------------|----------------------------|----------------------------|--------------------------|--------------------------|
|                        | <b>UX</b>                             | <b>U8K</b>                 | <b>U7K</b>                 | <b>U6K Pro</b>           | <b>U6K</b>               |
| Screen Size            | 85"/75"                               | 65"                        | 65"                        | 75"/65"/55"              | 65"/55"                  |
| Engine                 | Hi-View Engine X                      | Hi-View Engine             | Hi-View Engine             | Hi-View Engine           | Hi-View Engine           |
| Resolution             | 4K                                    | 4K                         | 4K                         | 4K                       | 4K                       |
| Upscaler               | 4K AI Upscaler                        | 4K AI Upscaler             | 4K AI Upscaler             | 4K AI Upscaler           | 4K AI Upscaler           |
| Backlight              | Mini-LED X                            | Mini-LED PRO               | Mini-LED                   | Mini-LED                 |                          |
| Dimming                | Full Array Local Dimming              | Full Array Local Dimming   | Full Array Local Dimming   | Full Array Local Dimming | Full Array Local Dimming |
| Colour                 | Quantum Dot Colour                    | Quantum Dot Colour         | Quantum Dot Colour         | Quantum Dot Colour       | Quantum Dot Colour       |
| Peak Brightness        | 2000+ nits Peak Brightness            | 1300+ nits Peak Brightness | 1000+ nits Peak Brightness | Peak Brightness 600      | Peak Brightness 600      |
| Dolby Vision®          | Dolby Vision IQ™                      | Dolby Vision IQ™           | Dolby Vision IQ™           | Dolby Vision™ HDR        | Dolby Vision™ HDR        |
| HDR10+                 | HDR10+ Adaptive                       | HDR10+ Adaptive            | HDR10+ Adaptive            | HDR10+                   | HDR10+                   |
| FILMMAKER MODE™        | ✓                                     | ✓                          | ✓                          | ✓                        |                          |
| IMAX® Enhanced         | ✓                                     | ✓                          | ✓                          |                          |                          |
| Motion                 | 120Hz Ultra Motion                    | 120Hz Ultra motion         | 120Hz Ultra Motion         | Smooth Motion            | Smooth Motion            |
| Screen                 | Dynamic X-Display                     | Ultra Viewing Angle        |                            |                          |                          |
| Multi-Channel Surround | 4.1.2                                 | 2.1.2                      |                            |                          |                          |
| Speaker Design         | CineStage X Surround                  | Front-Firing Speaker       |                            |                          |                          |
| Audio Enhancement      | Dolby Atmos®                          | Dolby Atmos®               | Dolby Atmos®               | Dolby Atmos®             | Dolby Atmos®             |
| Speaker Connectivity   | eARC<br>WISA Ready                    | eARC<br>WISA Ready         | eARC<br>EZPlay             | eARC<br>EZPlay           | eARC<br>EZPlay           |
| Stand Design           | 85" :Dual Stand<br>75" : Single Stand | Single Stand               | Dual Stand                 | Dual Stand               | Dual Stand               |
| Cable Solution         | ✓                                     | ✓                          | ✓                          | ✓                        | ✓                        |
| Pure Metal Stand       | ✓                                     | ✓                          | ✓                          | ✓                        | ✓                        |
| Game Mode              | 144Hz Game Mode Pro                   | 144Hz Game Mode Pro        | 144Hz Game Mode Pro        | Game Mode Plus           | Game Mode Plus           |
| Gaming in Dolby Vision | ✓                                     | ✓                          | ✓                          |                          |                          |
| AMD FreeSync           | FreeSync Premium                      | FreeSync Premium           | FreeSync Premium           |                          |                          |
| AI Picture             | ✓                                     | ✓                          | ✓                          | ✓                        | ✓                        |
| AI Sports Mode         | ✓                                     | ✓                          | ✓                          | ✓                        | ✓                        |
| Voice Input            | Hands-Free Voice Control              | Hands-Free Voice Control   | Hands-Free Voice Control   |                          |                          |
| Voice Assistant        | VIDAA Voice                           | VIDAA Voice                | VIDAA Voice                | VIDAA Voice              | VIDAA Voice              |
| AirPlay®               | ✓                                     | ✓                          | ✓                          | ✓                        | ✓                        |
| Smart Home Ready       | Works with Apple Home™                | Works with Apple Home™     | Works with Apple Home™     | Works with Apple Home™   | Works with Apple Home™   |
| Operating System       | VIDAA                                 | VIDAA                      | VIDAA                      | VIDAA                    | VIDAA                    |
| Wi-Fi                  | Wi-Fi 6E                              | Wi-Fi 6E                   | Dual Band Wi-Fi            | Dual Band Wi-Fi          | Dual Band Wi-Fi          |
| Bluetooth              | ✓                                     | ✓                          | ✓                          | ✓                        | ✓                        |

|                  | UHD 4K                       | UHD 4K                                     | SMART TV        |
|------------------|------------------------------|--|-----------------|
|                  | A7K                          | A6K  | A4K             |
| Screen Size      | 85"/75"/65"/55"              | 70"/65"/58"/55"/50"                        | 43"/40"/32"     |
| Resolution       | 4K                           | 4K   | 2K              |
| Upscaler         | 4K AI Upscaler               | 4K AI Upscaler                             |                 |
| Colour           | Wide Colour Gumut            | Wide Colour Gumut                          |                 |
| Dolby Vision     | Dolby Vision™ HDR            | Dolby Vision™ HDR                          |                 |
| HDR10            | HDR10+                       | HDR10                                      |                 |
| Motion           | Smooth Motion                | 70" Smooth Motion                          |                 |
| Audio            | Dolby Atmos®                 | DTS® Virtual:X™                            | DTS® Virtual:X™ |
| eARC             | ✓                            | ✓  |                 |
| Stand Design     | Variable Feet Position (75") | Dual Stand<br>Variable Feet Position (65") | Dual Stand      |
| Game Mode        | Game Mode Plus               | Game Mode Plus                             | Game Mode       |
| AI Picture       | ✓                            | ✓  |                 |
| AI Sports Mode   | ✓                            | ✓  | ✓               |
| Voice Remote     | ✓                            | ✓  |                 |
| Smart Home Ready | ✓                            | ✓  |                 |
| Operating System | VIDAA                        | VIDAA                                      | VIDAA           |
| Wi-Fi            | Dual Band Wi-Fi              | Dual Band Wi-Fi                            | Wi-Fi           |
| Bluetooth        | ✓                            | ✓  |                 |







# LASER TV

## COLLECTION

2023 - 2024

# Why Laser TV

## 01. Innovative Laser Display Technology

Enjoy all the benefits that this cutting edge technology brings to you. Watch with excitement, refreshing pictures with natural colours and ultra-clear details, not forgetting a physically healthier way of viewing experience.

## Remarkable Picture Quality (For Lifelike images) 02.

Pure laser light source enhanced colour gamut, which leads to more natural colours with high purity and saturation. You will feel awakened by what you see on Laser TV.

## 03. Bringing Cinema Home

Rethink how you watch your favourite movies, boxsets and sporting events with the Hisense Laser TV, giving you a cinematic and immersive experience in the comfort of your home.

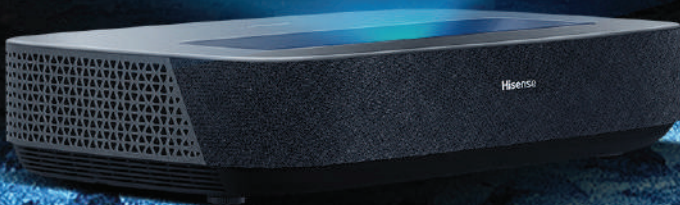

# Laser TV vs Projector



## Ultra-short-throw Distance

The Hisense Laser TV has an ultra-short-throw distance of just tens of centimeters for 100" or 120" from console to screen, while a conventional projector requires a 6m distance from the screen.



## Ultimate Brightness

Brighter and more clearer images. The Hisense Laser TV has 3000+ lumens as opposed to a projector which only has 1 500 lumen.



## 25 000+ Hours of Entertainment

The Hisense Laser TV has a lifespan of 25 000+ hours while projectors only last around 6 000 hours.

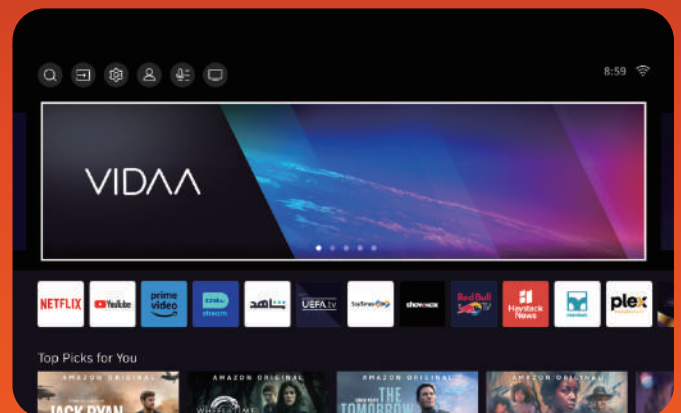

## Smart TV

The Hisense Laser TV has a built-in VIDAA U6 Smart system & built-in tuners, while projectors do not.

\* Take L9H for reference

# Laser TV vs LED TV

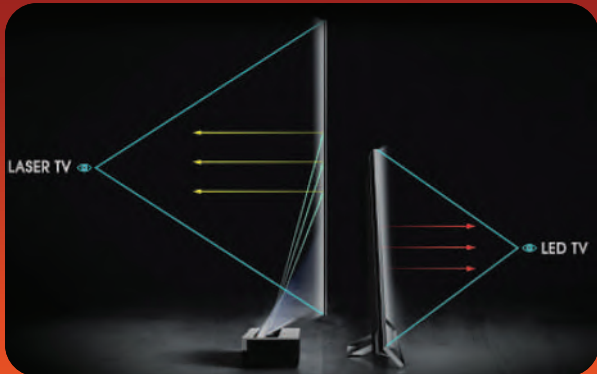

## No Eyestrain

With the screen requiring no electricity to function, you will experience zero electromagnetic radiation. Images are projected onto an anti-reflective screen and back into your eyes.



## Cinematic Viewing

The 100" Laser TV can be viewed from just 4m away compared to a 65" LED TV, while the 120" Laser TV can be viewed from 4.5m away compared to 75" LED TV

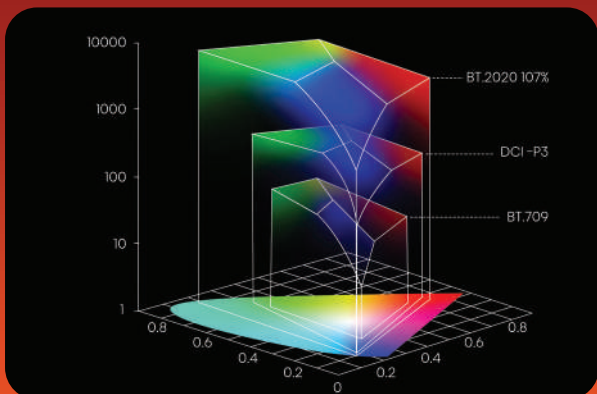

## Wide Colour Gamut

The Hisense Laser TV maximises colour production through its Ultra Colour Enhancer and Wide Colour Gamut technology, resulting in authentic, true-to-life pictures over that of LED TVs.



## Simplicity & Elegance

The Hisense Laser TV is light in weight and has a very elegant and slim screen design which gives you more screen to view your best shows



# Certificate and Media Awards



# L9H Series

120"



## Triple Colour Laser Light

With more than 1300 applied patents, from 2K to 4K, single colour to triple colour, Hisense are pioneers in the Laser TV industry and continue to produce cutting-edge product.



## Unparalleled brightness

High Luminance uniformity ensures the brightness at each position on screen stays consistent, generates brighter images.

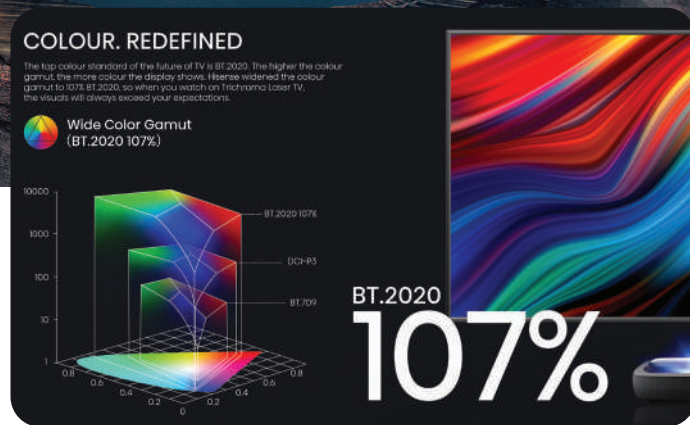

## Colour Redefined

Hisense widened the colour gamut to 107% BT.2020, so when you watch on Trichroma Laser TV, the visuals will always exceed your expectations.



## Dolby Vision · Atmos

Dolby Vision HDR dynamically optimises colour, contrast and brightness. And with the sensation of sound moving around you, Dolby Atmos can help you feel like you're right inside the action

# L5H Series

100"



## Ultra Short Throw Laser TV

Only 29.7cm for 100" to the screen, it is very easy to install and fit in your living room.



## Flexible ALR screen

The Laser TV display uses Ambient Light Rejecting technology to boost image brightness and keep colours from appearing washed out.



## Dolby Vision · Atmos

Dolby Vision HDR dynamically optimises colour, contrast and brightness. And with the sensation of sound moving around you, Dolby Atmos can help you feel like you're right inside the action



## Eye-friendly

The image you see on Laser TV is reflected instead of directly projected towards your eyes with almost 0 harmful blue light exposure. This means putting less strain on your eyes, even when you watch TV for a longer time.



# PX1-PRO

Projection Size: 90" – 130"

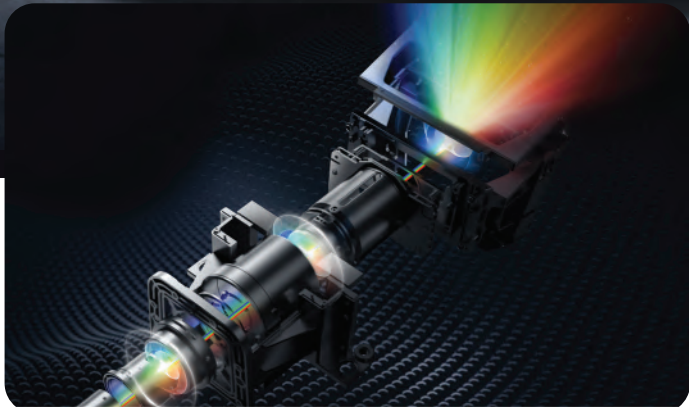

## TriChroma

Experience colour like never before, The PX1-PRO uses pure red, green and blue lasers to achieve new levels of colour performance.

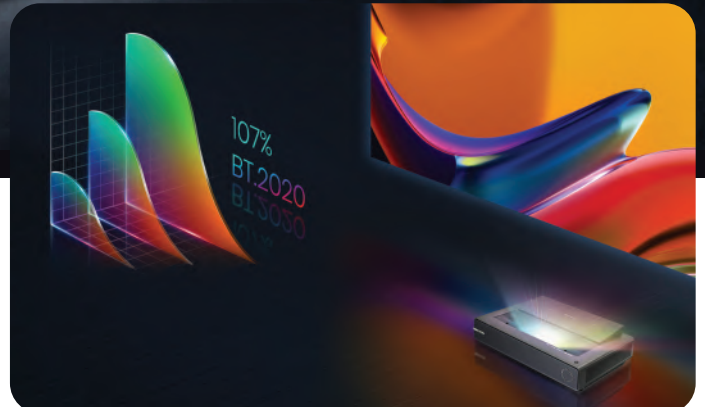

## Colour Redefined

Hisense widened the colour gamut to 107% BT.2020, so when you watch on Trichroma Laser TV, the visuals will always exceed your expectations.



## Dolby Vision

With support for HDR10, HLG, and Dolby Vision, Laser cinema can leverage High Dynamic Range to further expand the heights and depths of colour and contrast.



## Dolby Atmos

Get an HDMI 2.1 port with eACR support so you can squeeze out every high-bitrate audio detail from your Dolby Atmos sound system.



**C1** Projection Size:  
65" – 300"

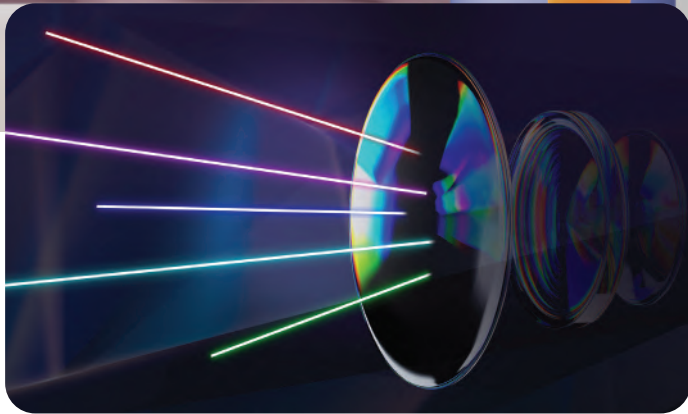

### 4K TriChroma Laser Projection

The best Laser technology ever used on a mini projector. See the real colour of the future anywhere you want.



### Colour Redefined

Hisense widened the colour gamut to 110% BT.2020, so when you watch on Trichroma Laser projection, the visuals will always exceed your expectations.



### Dolby Vision

C1 is the world's first ever mini projector equipped with Dolby Vision, along with HDR10 and HLG, C1 offers incredibly rich and satisfying colours within precision contrast.



### Theater-like Sound by JBL Sound

C1 paired with JBL audio solution that produces punchy bass and clear treble, resonance in the grandiose 1L sound chamber, so you can hear every note and detail.

# Hisense Laser TV

## Platinum Service T&C's apply

01. 1 year warranty    02. Free basic installation    03. Free delivery

### MODEL INFORMATION

| Model                       | L9H                | L5H                | PX1-PRO            | C1                 |
|-----------------------------|--------------------|--------------------|--------------------|--------------------|
| Size (W x H x D mm)         | 610 x 155 x 346    | 566 x 121 x 320    | 520 x 160 x 324    | 245 x 179 x 216    |
| Weight (kg)                 | 11.2               | 9.4                | 9.2                | 4.6                |
| Light Source                | Triple color Laser | Single color Laser | Triple color Laser | Triple color Laser |
| Lifetime (h)                | 25000              | 25000              | 25000              | 25000              |
| Display Tech                | DLP 0.47" DMD      | DLP 0.47" DMD      | DLP 0.47" DMD      | DLP 0.47" DMD      |
| Audible Noise (dB)          | 32                 | 32                 | 32                 | 26                 |
| Throw Ratio                 | 0.25               | 0.25               | 0.25               | 1.2                |
| Screen Size                 | 120"               | 100"               | 90~130"            | 65~300"            |
| Focus                       | No                 | No                 | No                 | Yes                |
| Digital keystone correction | 9 points           | 9 points           | 9 points           | Yes                |

### PICTURE

|                   |   |   |   |   |
|-------------------|---|---|---|---|
| Resolution        | 4K UHD                                      | 4K UHD                                      | 4K UHD                                      | 4K UHD                                      |
| Luminance (lm)    | 3000  | 2700  | 2200  | 1600  |
| Wide Colour Gamut | BT.2020 107%, NTSC 145%, DCI-P3 151%        | DCI-P3 85%                                  | BT.2020 107%, NTSC 145%, DCI-P3 151%        | BT.2020 110%, NTSC 145%, DCI-P3 151%        |
| Native Contrast   | 1000:1                                      | 3000:1                                      | 1000:1                                      | 1600:1                                      |
| Dynamic Contrast  | 2000000:1                                   | 2000000:1                                   | 2000000:1                                   | 2000000:1                                   |
| HDR               | Dolby Vision, HDR10+ (decoding), HDR10, HLG | Dolby Vision, HDR10+ (decoding), HDR10, HLG | Dolby Vision, HDR10+ (decoding), HDR10, HLG | Dolby Vision, HDR10+ (decoding), HDR10, HLG |
| Smooth motion     | Yes   | Yes   | Yes   | Yes   |
| Game mode         | Yes   | Yes   | Yes   | Yes   |
| Filmmaker mode    | Yes   | Yes   | Yes   | Yes   |

### AUDIO

|              |             |             |             |                     |
|--------------|-------------|-------------|-------------|---------------------|
| Output Power | 20W x 2     | 20W x 2     | 15W x 2     | 10W x 2             |
| Tech         | Dolby Atmos | Dolby Atmos | Dolby Atmos | by JBL, Dolby Atmos |

### SMART

|                 |   |   |   |   |
|-----------------|---|---|---|---|
| Platform        | MT9900                                  | MT9900                                  | MT9900                                  | MT9900                                  |
| OS              | VIDAA U6                                | VIDAA U6                                | VIDAA U6                                | VIDAA U6                                |
| Voice assistant | Yes                                     | Yes                                     | Yes                                     | Yes                                     |
| Key apps        | Netflix, YouTube, Prime Video, Apple TV | Netflix, YouTube, Prime Video, Apple TV | Netflix, YouTube, Prime Video, Apple TV | Netflix, YouTube, Prime Video, Apple TV |

### CONNECTIVITY

|              |                          |                             |                          |                             |
|--------------|--------------------------|-----------------------------|--------------------------|-----------------------------|
| TV Tuner     | Yes                      | Yes                         | No                       | No                          |
| HDMI         | HDMI 2.1*                | HDMI 2.1* x 1, HDMI 2.0 x 2 | HDMI 2.1* x 2            | HDMI 2.1* x 1, HDMI 2.0 x 1 |
| USB          | USB 3.0 x 1, USB 2.0 x 1 | USB 3.0 x 1, USB 2.0 x 1    | USB 3.0 x 1, USB 2.0 x 1 | USB 3.0 x 1, USB 2.0 x 1    |
| SPDIF        | Optical x 1              | Optical x 1                 | Optical x 1              | Optical x 1                 |
| Audio in/out | Audio out (3.5mm) x 1    | Audio out (3.5mm) x 1       | Audio out (3.5mm) x 1    | Audio out (3.5mm) x 1       |
| LAN          | RJ-45 x 1                | RJ-45 x 1                   | RJ-45 x 1                | RJ-45 x 1                   |
| Bluetooth    | Yes                      | Yes                         | Yes                      | Yes                         |
| WiFi         | Yes                      | Yes                         | Yes                      | Yes                         |
| AirPlay 2    | Yes                      | Yes                         | Yes                      | Yes                         |
| Control 4    | OTA update               | OTA update                  | OTA update               | Yes                         |

\*ALLM, eARC



# AUDIO

## COLLECTION

2023 - 2024

Hear the  
*Emotion*

## Ultimate Entertainment Experience



Hear loud and clear, by experiencing complete sound immersion.



Make every seat, the best seat in the house, with spatial room correction and free-sit tech that delivers the best sound experience.



Enjoy complete synchronization between picture and sound. Optimizing speakers in both the tv and soundbar will upgrade your entertainment experience.

## Audio Family

U series

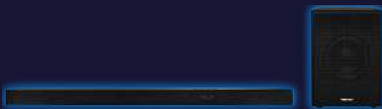

Hi-Res AUDIO pure surround Dolby Atmos Dolby Audio dts x dts WMA

AX series



pure surround Dolby Atmos Dolby Audio dts x dts WMA

HS series

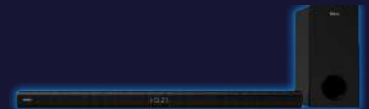

Dolby Audio dts WMA



Matching TV: ULED series Size ≥ 65"



Matching TV: OLED Series Size ≥ 55"



Matching TV: UHD series Size ≥ 43"

# NATURE HEAR-THROUGH U5120G

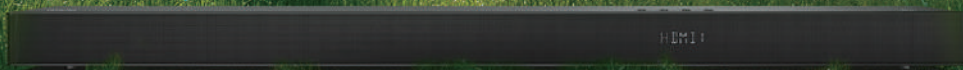

## U5120G

Theater experience at home, perfect for your TV

Hisense TVs have met their perfect match, a multi dimension and acinematic audio system, which delivered from a 5.1.2 channel Soundbar-U5120G. Up-firing and side-firing speakers immerse you in pure, realistic sound-surrounding environment, as you're transported into the center of the action.

### 1 Sound power

- 510W audio power
- 12 speakers create 5.1.2ch
- 8 inch \* 180W subwoofer

### 2 Immersive tech

- Hi-Res
- Dolby Atmos
- DTS:X
- Hi-Remaster

### 3 EQ

- AI
- Movie
- Music
- Game
- Sports
- Night
- News

### 4 Friendly use

- EzPlay
- 4K Pass through
- Muti-connections

**Hi-Res  
Certificated**

6.5 times CD audio      35 times MP3 audio

Less detail ←      → More detail

|              |           |                       |           |
|--------------|-----------|-----------------------|-----------|
| 128-320 kbps | 1411 kbps | 1536 kbps             | 4608 kbps |
| MP3          | CD        | High resolution audio |           |
| Lossy        | Lossless  |                       |           |

**Hi-Res  
AUDIO**

# EVERY WAVE STARTS WITH A RIPPLE

## Soundbar U3120G

# RIPPLE



### U3120G

The perfect combination of Vision and Sound

U3120G optimal paired with Hisense UHD TVs, complimented with powerful speakers and Dolby Atmos/Dts:X, create an indescribably sound experience, completely beyond imagination.

#### 1 Sound power

- 420W audio power
- 9 speakers create 3.1.2ch
- 8 inch \* 180W subwoofer

#### 2 Immersive tech

- Dolby Atmos
- DTS:X

#### 3 EQ

- AI
- Movie
- Music
- Game
- Sports
- Night
- News

#### 4 Friendly use

- EzPlay
- 4K Pass through
- Multi-connections



# Simplicity in Sound

## AX5100G



### AX5100G

AX5100G, bring out the best in audio visual experience. Providing the perfect balance of power and quality.

#### 1 Sound power

- 340W Max audio power
- 7 speakers
- 6.5 inch subwoofer

#### 2 Immersive tech

- Dolby Atmos
- DTS:X
- True back surround

#### 3 EQ

- AI
- Movie
- Music
- Game
- Sports
- Night
- News

#### 4 Friendly use

- EzPlay
- Multi-connections
- Bluetooth 5.0

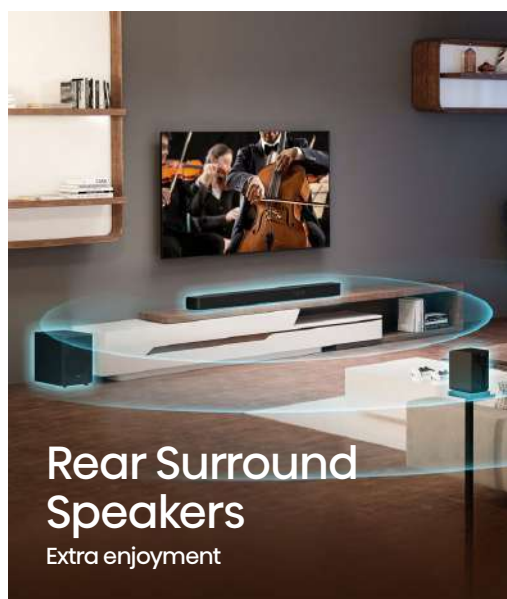

### Rear Surround Speakers

Extra enjoyment

# Simplicity in Sound

## AX3100G



### AX3100G

AX3100G, bring out the best in audio visual experience. Providing the perfect balance of power and quality.

#### 1 Sound power

- 280W Max audio power
- 5 speakers
- 6.5 inch subwoofer

#### 2 Immersive tech

- Dolby Atmos
- DTS:X

#### 3 EQ

- AI
- Movie
- Music
- Game
- Sports
- Night
- News

#### 4 Friendly use

- EzPlay
- Multi-connections
- Bluetooth 5.0



## Perfect Sound

Powerful yet comfortable



# Simplicity in Sound

## AX2107G



### AX2107G

As TV mate, Hisense AX2107G focuses on evaluating your visual experience, helps to deliver spacious and realistic audio performance. And simple connection ready in seconds.

#### 1 Sound power

- 300W Max audio power
- 4 speakers
- 6.5 inch subwoofer

#### 2 Immersive tech

- Dolby Atmos
- PCM

#### 3 EQ

- AI
- Movie
- Music
- Game
- Sports
- Night
- News

#### 4 Friendly use

- eARC
- Multi-connections
- Bluetooth 5.2





# THE BEAST

## Unleash TV Sound | HS2100

### HS2100

HS2100, the beast, the perfect mate for TV, the right one to unleash your TV sound.

#### 1 Sound power

- 240W Max audio power
- 5.25 inch subwoofer

#### 2 Immersive tech

- Dolby Atmos
- DTS:X
- TV Mode

#### 3 EQ

- Movie
- Music
- Game
- Sports
- Night
- News

#### 4 Friendly use

- EzPlay
- Multi-connections
- Bluetooth 5.3



### TV Mode

Greatly enhance sound

# Ultimate Party Starter

## Party Rocker ONE

Creating endless memories

With friends

With family

By yourself

To Dance

To Enjoy

To Party



# 300W

300W\* all-round speaker  
\*Max audio power

5.25"X 2 2.25"X 2

# 15 hours



## Long-lasting battery

Enjoy the party for 15 hours



## 5 lighting effects

Let the light follow your rhythm

## Karaoke mode

Wireless microphone shows off your voice



## Wireless charge your phone

Phone Only

## 5 DJ effects

Cheer up your mood

## IPX4 waterproof on top-panel

Anti-splash

Car Charge

Vocal Fader

Built-in FM

Guitar Input

Group Play

Bluetooth 5.0



# REFRIGERATION and Freezer

---

## COLLECTION

2023 - 2024

# CONTROL YOUR REF VIA MOBILE PHONE

## Smart Connectivity

Thanks to the smart WI-FI mode, your life is a lot more convenient. Adjust your refrigerator's temperature settings anywhere anytime, using your smart companion – ConnectLife App.



## Screen Sharing

Need to cook meal but don't want to miss what's happening during the big game? You can mirror your phone to the big touch screen on the refrigerator. Never miss any great moment.



## 

This refrigerator can analyze your door opening times based on your usage habits.



## Smart diagnostic

The smart diagnostic feature allows you to quickly check diagnostic results. The refrigerator will perform a self-diagnosis scan and report any problems found.



## Shopping List

The shopping list feature allows you to stay organized before going to the store. You can create a shopping list using touch screen, and it will be automatically updated on your smartphone.



## Food Inventory

The food inventory feature allows you to view and adjust the temperature and settings of your refrigerator. You can name the items with expiration dates, then you'll receive notifications when they've expired.



## Impressive Recipes

The impressive recipes allow you to access 150+ recipes and help you decide what to cook for the week, reducing the stress when you are out of dinner ideas.



# LEAVING NOTES AND DRAWINGS TO YOUR FAMILY

## Message Board

You can use message board to leave reminders or post notes for your family. This is a fun and helpful feature that you will love.



# ALWAYS HAVE ICE & WATER ON HAND



## Ice & water Dispenser

Hisense's elegant Ice & Water Dispenser offers three unique settings: refreshing water, cubed, and crushed ice. Enjoy a glass of refreshing water or cool off any beverage whenever you want it.

## Life is always more than one choice

Without opening the fridge door, you can choose out of ice cubes, crushed ice or chilled water.

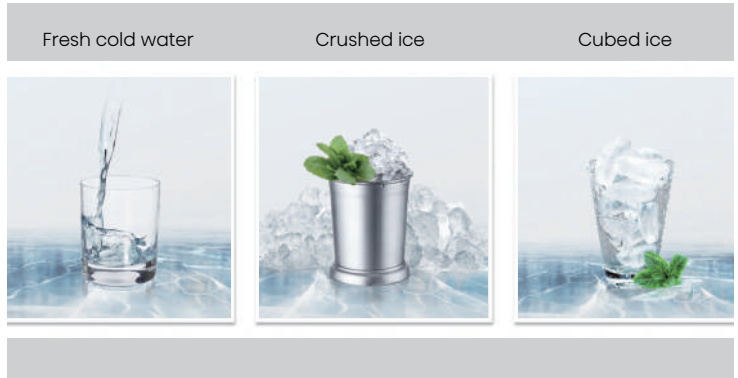

## No plumbed water dispenser

The stylish non-plumbed ice and water dispenser offers everyday convenience of cooled water on tap, while also ensuring your fridge to be installed quickly and easily.



## Antibacterial Guard

By eliminating up to 99.999 % of bacteria, this refrigerator keeps your food fresh for a longer period of time. Thanks to highly effective antibacterial liner inside, the fridge is bacteria-free, making it more clean and healthy to use.



## Metal-Tech Cooling

The rear wall of the fridge is overlaid with stainless steel, which ensures the cool air is distributed evenly from the inside out. This combination of advanced technologies ensures ideal temperature and humidity levels at all time.



## Triple Zone

This fridge-freezer is fully adaptable to your needs. It has three different compartments with flexible temperatures – fridge, freezer, and My Fresh Choice section, each with their own controls. You can set the fridge and the freezer to whatever temperature suits you most.

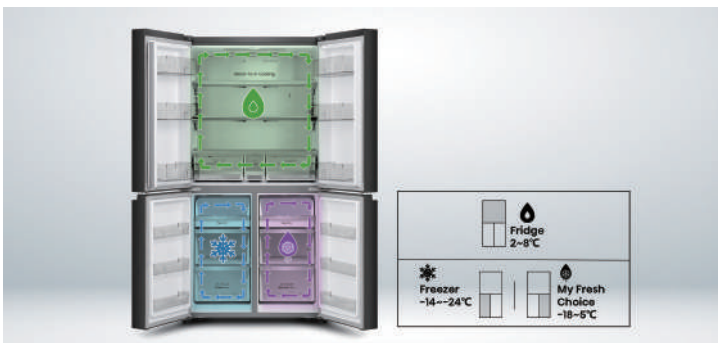

# EASILY CONVERTED FROM FRIDGE TO FREEZER

## My Fresh Choice

My fresh choice, the middle compartment, can easily be converted from a fridge and freezer with  $-18^{\circ}\text{C}$ ~ $+5^{\circ}\text{C}$  temperature setting. By creating the perfect temperature environment you need, you can prolong the freshness and taste quality of your desired food efficiently.







## Recessed Metal Handle

The stylish recessed metal handles give access to easy open doors. The brushed design makes the handle easily fit into any kitchen design.

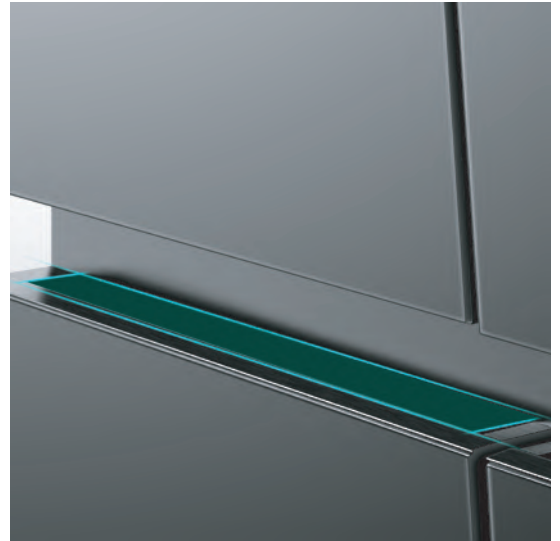

## Metal Glide Drawers

All frozen items, even the largest ones, can now be reached easier and quicker, thanks to the durable metal easy-glide runners. Transparent design of the drawers, offers clear overview of the content.



## Durable Inverter

The modern inverter compressor measures the conditions inside your fridge and adjust the cooling output accordingly, to ensure a stable temperature, save energy and run quieter, while also extending your appliance' s lifespan.



## Dual-tech Cooling

The Dual-Tech Cooling system prolongs ideal humidity levels for an odour-free refrigerator and prolonged freshness of the stored food. By assuring different humidity levels in the cooling and freezer compartments, it prevents any mixing of odours and maintains a perfect climate in each part of the fridge.



## Cantilever Shelves

Enjoy flexibility with the cantilever shelves. If you want more space between the shelves, simply take one out and place it on a different shelf-holder. That way you can tailor the inside of the fridge specially to your needs, therefore, all the large bottles, mason jars or tall cakes will fit perfectly inside the fridge.



## Gallon Door Storage

Plenty of space to store large bottled beverages and other items in the fridge door thanks to Gallon Door Storage, which frees up space in the rest of the fridge.



## Large Capacity

The refrigerator has a big capacity, so there's plenty of space in the fridge and freezer to store any shape or type of food. The refrigerator also has four doors that open out widely, so you can see everything at a glance.



## Cross Door Series



| Catalogue Model         | RC-68WCD     | RC-68WCS     |
|-------------------------|--------------|--------------|
| <b>Net Capacity</b>     |              |              |
| Total                   | 535          | 543          |
| Refrigerator            | 344          | 352          |
| Freezer                 | 191          | 191          |
| <b>General Features</b> |              |              |
| Temp Control/ Display   | Computer     | Computer     |
| Defrosting              | Automatic    | Automatic    |
| Refrigerant             | R600a        | R600a        |
| Climate Type            | SN-T         | SN-T         |
| <b>Dimensions</b>       |              |              |
| Net(W × D × H)(mm)      | 912x725x1785 | 912x725x1785 |
| Weight(Net/ Gross Kg)   | 150/159      | 133/142      |

## Cross Door Series



| Catalogue Model         | RC-68WCB     |
|-------------------------|--------------|
| <b>Net Capacity</b>     |              |
| Total                   | 543          |
| Refrigerator            | 352          |
| Freezer                 | 191          |
| <b>General Features</b> |              |
| Temp Control/ Display   | Computer     |
| Defrosting              | Automatic    |
| Refrigerant             | R600a        |
| Climate Type            | SN-T         |
| <b>Dimensions</b>       |              |
| Net(W × D × H)(mm)      | 912x725x1785 |
| Weight(Net/ Gross Kg)   | 133/142      |

## French Door Series



| Catalogue Model         | RM-64WC      |
|-------------------------|--------------|
| <b>Net Capacity</b>     |              |
| Total                   | 560          |
| Refrigerator            | 329          |
| Freezer                 | 212          |
| <b>General Features</b> |              |
| Temp Control/ Display   | Computer     |
| Defrosting              | Automatic    |
| Refrigerant             | R600a        |
| Climate Type            | SN-T         |
| <b>Dimensions</b>       |              |
| Net(W × D × H)(mm)      | 908x725x1785 |
| Weight(Net/ Gross Kg)   | 141/152      |

## Cross Door Series



| Catalogue Model         | RQ-56WC      | RQ-56WCB     |
|-------------------------|--------------|--------------|
| <b>Net Capacity</b>     |              |              |
| Total                   | 432          | 432          |
| Refrigerator            | 290          | 290          |
| Freezer                 | 142          | 142          |
| <b>General Features</b> |              |              |
| Temp Control/ Display   | Computer     | Computer     |
| Defrosting              | Automatic    | Automatic    |
| Refrigerant             | R600a        | R600a        |
| Climate Type            | SN-T         | SN-T         |
| <b>Dimensions</b>       |              |              |
| Net(W × D × H)(mm)      | 794x700x1810 | 794x700x1810 |
| Weight(Net/ Gross Kg)   | 110/116      | 110/116      |

## Side-by-side Series



| Catalogue Model         | RC-82WS          | RS-87WS          |
|-------------------------|------------------|------------------|
| <b>Net Capacity</b>     |                  |                  |
| Total                   | 632              | 637              |
| Refrigerator            | 417              | 416              |
| Freezer                 | 215              | 221              |
| <b>General Features</b> |                  |                  |
| Temp Control/ Display   | Touch/Electrical | Touch/Electrical |
| Defrosting              | Automatic        | Automatic        |
| Refrigerant             | R600a            | R600a            |
| Climate Type            | SN-T             | SN-T             |
| <b>Dimensions</b>       |                  |                  |
| Net(W × D × H)(mm)      | 910x730x1790     | 910x717x1795     |
| Weight(Net/ Gross Kg)   | 129/140          | 100/110          |

## Side-by-side Series



| Catalogue Model         | RC-76WSN         | RC-67BGL         |
|-------------------------|------------------|------------------|
| <b>Net Capacity</b>     |                  |                  |
| Total                   | 569              | 509              |
| Refrigerator            | 374              | 335              |
| Freezer                 | 195              | 174              |
| <b>General Features</b> |                  |                  |
| Temp Control/ Display   | Touch/Electrical | Touch/Electrical |
| Defrosting              | Automatic        | Automatic        |
| Refrigerant             | R600a            | R600a            |
| Climate Type            | SN-T             | SN-T             |
| <b>Dimensions</b>       |                  |                  |
| Net(W × D × H)(mm)      | 910x693x1786     | 910x643x1786     |
| Weight(Net/ Gross Kg)   | 118/128          | 100/108          |

## Side-by-side Series



| Catalogue Model         | RC-67WS          | RC-67WSI         |
|-------------------------|------------------|------------------|
| <b>Net Capacity</b>     |                  |                  |
| Total                   | 508              | 509              |
| Refrigerator            | 334              | 335              |
| Freezer                 | 174              | 174              |
| <b>General Features</b> |                  |                  |
| Temp Control/ Display   | Touch/Electrical | Touch/Electrical |
| Defrosting              | Automatic        | Automatic        |
| Refrigerant             | R600a            | R600a            |
| Climate Type            | SN-T             | SN-T             |
| <b>Dimensions</b>       |                  |                  |
| Net(W × D × H)(mm)      | 910x643x1786     | 910x643x1786     |
| Weight(Net/ Gross Kg)   | 83/83            | 89/97            |

## Side-by-side Series



| Catalogue Model         | RC-55WS          |
|-------------------------|------------------|
| <b>Net Capacity</b>     |                  |
| Total                   | 445              |
| Refrigerator            | 273              |
| Freezer                 | 172              |
| <b>General Features</b> |                  |
| Temp Control/ Display   | Touch/Electrical |
| Defrosting              | Automatic        |
| Refrigerant             | R600a            |
| Climate Type            | SN-T             |
| <b>Dimensions</b>       |                  |
| Net(W × D × H)(mm)      | 836x636x1780     |
| Weight(Net/ Gross Kg)   | 68/75            |

## Top-mounted Nofrost Series



| Catalogue Model         | RD-73WR      |
|-------------------------|--------------|
| <b>Net Capacity</b>     |              |
| Total                   | 557          |
| Refrigerator            | 440          |
| Freezer                 | 117          |
| <b>General Features</b> |              |
| Temp Control/ Display   | Electronics  |
| Defrosting              | Automatic    |
| Refrigerant             | R600a        |
| Climate Type            | SN-T         |
| <b>Dimensions</b>       |              |
| Net(W × D × H)(mm)      | 794x726x1852 |
| Weight(Net/ Gross Kg)   | 89/97        |

## Top-mounted Nofrost Series



| Catalogue Model         | REF565DRI    | RD-66WR      |
|-------------------------|--------------|--------------|
| <b>Net Capacity</b>     |              |              |
| Total                   | 548          | 504          |
| Refrigerator            | 431          | 387          |
| Freezer                 | 117          | 117          |
| <b>General Features</b> |              |              |
| Temp Control/ Display   | Electronics  | Electronics  |
| Defrosting              | Automatic    | Automatic    |
| Refrigerant             | R600a        | R600a        |
| Climate Type            | SN-T         | SN-T         |
| <b>Dimensions</b>       |              |              |
| Net(W × D × H)(mm)      | 794x726x1852 | 794x685x1720 |
| Weight(Net/ Gross Kg)   | 89/97        | 78/85        |

## Top-mounted Nofrost Series



| Catalogue Model         | REF240DR     | REF205DR     |
|-------------------------|--------------|--------------|
| <b>Net Capacity</b>     |              |              |
| Total                   | 240          | 205          |
| Refrigerator            | 183          | 164          |
| Freezer                 | 57           | 41           |
| <b>General Features</b> |              |              |
| Temp Control/ Display   | Mechanical   | Mechanical   |
| Defrosting              | Manual       | Manual       |
| Refrigerant             | R600a        | R600a        |
| Climate Type            | SN-T         | SN-T         |
| <b>Dimensions</b>       |              |              |
| Net(W × D × H)(mm)      | 540x540x1772 | 550x542x1434 |
| Weight(Net/ Gross Kg)   | 53/58        | 39/42.5      |

## Top-mounted Nofrost Series



| Catalogue Model         | REF205DRB    | REF200DR     |
|-------------------------|--------------|--------------|
| <b>Net Capacity</b>     |              |              |
| Total                   | 205          | 154          |
| Refrigerator            | 164          | 113          |
| Freezer                 | 41           | 41           |
| <b>General Features</b> |              |              |
| Temp Control/ Display   | Mechanical   | Mechanical   |
| Defrosting              | Manual       | Manual       |
| Refrigerant             | R600a        | R600a        |
| Climate Type            | SN-T         | SN-T         |
| <b>Dimensions</b>       |              |              |
| Net(W × D × H)(mm)      | 550x542x1434 | 475x491x1440 |
| Weight(Net/ Gross Kg)   | 39/42.5      | 33/36        |

## Top-mounted Nofrost Series



| Catalogue Model         | REF172DR     |
|-------------------------|--------------|
| <b>Net Capacity</b>     |              |
| Total                   | 124          |
| Refrigerator            | 96           |
| Freezer                 | 28           |
| <b>General Features</b> |              |
| Temp Control/ Display   | Mechanical   |
| Defrosting              | Manual       |
| Refrigerant             | R600a        |
| Climate Type            | SN-T         |
| <b>Dimensions</b>       |              |
| Net(W × D × H)(mm)      | 475x487x1169 |
| Weight(Net/ Gross Kg)   | 33/36        |

## Bottom-mount Defrost Series



| Catalogue Model         | REF308DR     |
|-------------------------|--------------|
| <b>Net Capacity</b>     |              |
| Total                   | 304          |
| Refrigerator            | 307          |
| Freezer                 | 97           |
| <b>General Features</b> |              |
| Temp Control/ Display   | Electronics  |
| Defrosting              | Manual       |
| Refrigerant             | R600a        |
| Climate Type            | SN-T         |
| <b>Dimensions</b>       |              |
| Net(W × D × H)(mm)      | 645x628x1935 |
| Weight(Net/ Gross Kg)   | 70/77        |

## Bottom-mount Defrost Series



| Catalogue Model         | RD-35DCB     | RD-29DCA     |
|-------------------------|--------------|--------------|
| <b>Net Capacity</b>     |              |              |
| Total                   | 262          | 225          |
| Refrigerator            | 196          | 159          |
| Freezer                 | 66           | 66           |
| <b>General Features</b> |              |              |
| Temp Control/ Display   | Mechanical   | Mechanical   |
| Defrosting              | Manual       | Manual       |
| Refrigerant             | R600a        | R600a        |
| Climate Type            | SN-T         | SN-T         |
| <b>Dimensions</b>       |              |              |
| Net(W × D × H)(mm)      | 550x557x1800 | 550x557x1610 |
| Weight(Net/ Gross Kg)   | 53/58        | 50/54        |



## Single Door Series



| Catalogue Model         | RR230S       | RR230SB      |
|-------------------------|--------------|--------------|
| <b>Net Capacity</b>     |              |              |
| Total                   | 179          | 179          |
| Refrigerator            | 156          | 156          |
| Freezer                 | 23           | 23           |
| <b>General Features</b> |              |              |
| Temp Control/ Display   | Mechanical   | Mechanical   |
| Defrosting              | Manual       | Manual       |
| Refrigerant             | R600a        | R600a        |
| Climate Type            | SN-T         | SN-T         |
| <b>Dimensions</b>       |              |              |
| Net(W × D × H)(mm)      | 515x514x1229 | 515x514x1229 |
| Weight(Net/ Gross Kg)   | 33/36        | 33/36        |

## Single Door Series



| Catalogue Model         | RR20S        | REF121DR    |
|-------------------------|--------------|-------------|
| <b>Net Capacity</b>     |              |             |
| Total                   | 150          | 119         |
| Refrigerator            | 150          | 119         |
| Freezer                 | 0            | 0           |
| <b>General Features</b> |              |             |
| Temp Control/ Display   | Mechanical   | Mechanical  |
| Defrosting              | Manual       | Manual      |
| Refrigerant             | R600a        | R600a       |
| Climate Type            | SN-T         | SN-T        |
| <b>Dimensions</b>       |              |             |
| Net(W × D × H)(mm)      | 515x514x1079 | 475x560x845 |
| Weight(Net/ Gross Kg)   | 28/31        | 31/33.5     |

## Single Door Series



| Catalogue Model         | REF093DR    | REF045DR    |
|-------------------------|-------------|-------------|
| <b>Net Capacity</b>     |             |             |
| Total                   | 90          | 44          |
| Refrigerator            | 90          | 44          |
| Freezer                 | 0           | 0           |
| <b>General Features</b> |             |             |
| Temp Control/ Display   | Mechanical  | Mechanical  |
| Defrosting              | Manual      | Manual      |
| Refrigerant             | R600a       | R600a       |
| Climate Type            | SN-T        | SN-T        |
| <b>Dimensions</b>       |             |             |
| Net(W × D × H)(mm)      | 475x448x842 | 445x468x500 |
| Weight(Net/ Gross Kg)   | 18.5/20.5   | 13.3/14.9   |

## Upright Freezer



| Catalogue Model         | RS189DR      |
|-------------------------|--------------|
| <b>Net Capacity</b>     |              |
| Total                   | 190          |
| Refrigerator            | 0            |
| Freezer                 | 190          |
| <b>General Features</b> |              |
| Temp Control/ Display   | Electronics  |
| Defrosting              | Automatic    |
| Refrigerant             | R600a        |
| Climate Type            | SN-T         |
| <b>Dimensions</b>       |              |
| Net(W × D × H)(mm)      | 550x559x1434 |
| Weight(Net/ Gross Kg)   | 45/49        |

## Chest Freezer



| Catalogue Model         | FC-91DD      | FC-66DD      |
|-------------------------|--------------|--------------|
| <b>Net Capacity</b>     |              |              |
| Total                   | 702          | 500          |
| Refrigerator            | 0            | 0            |
| Freezer                 | 702          | 500          |
| <b>General Features</b> |              |              |
| Temp Control/ Display   | Mechanical   | Mechanical   |
| Number of Door          | 2            | 2            |
| Refrigerant             | R600a/R290   | R600a/R290   |
| Climate Type            | SN-T         | SN-T         |
| <b>Dimensions</b>       |              |              |
| Net(W × D × H)(mm)      | 2145x758x826 | 1646x717x847 |
| Weight(Net/ Gross Kg)   | 86/96        | 74/83        |

## Chest Freezer



| Catalogue Model         | FC-55DD      | FC390SH      |
|-------------------------|--------------|--------------|
| <b>Net Capacity</b>     |              |              |
| Total                   | 420          | 297          |
| Refrigerator            | 0            | 0            |
| Freezer                 | 420          | 297          |
| <b>General Features</b> |              |              |
| Temp Control/ Display   | Mechanical   | Mechanical   |
| Number of Door          | 1            | 1            |
| Refrigerant             | R600a/R290   | R600a        |
| Climate Type            | SN-T         | SN-T         |
| <b>Dimensions</b>       |              |              |
| Net(W × D × H)(mm)      | 1448x717x852 | 1114x633x847 |
| Weight(Net/ Gross Kg)   | 58/64        | 40/44        |

## Chest Freezer



| Catalogue Model         | FC340SH      | FC320SH      |
|-------------------------|--------------|--------------|
| <b>Net Capacity</b>     |              |              |
| Total                   | 245          | 245          |
| Refrigerator            | 0            | 0            |
| Freezer                 | 245          | 245          |
| <b>General Features</b> |              |              |
| Temp Control/ Display   | Mechanical   | Mechanical   |
| Number of Door          | 1            | 1            |
| Refrigerant             | R600a        | R600a        |
| Climate Type            | SN-T         | SN-T         |
| <b>Dimensions</b>       |              |              |
| Net(W × D × H)(mm)      | 1002x597x842 | 1002x630x842 |
| Weight(Net/ Gross Kg)   | 37/39        | 35/40        |

## Chest Freezer



| Catalogue Model         | FC260SH     | FC250SH     |
|-------------------------|-------------|-------------|
| <b>Net Capacity</b>     |             |             |
| Total                   | 198         | 198         |
| Refrigerator            | 0           | 0           |
| Freezer                 | 198         | 198         |
| <b>General Features</b> |             |             |
| Temp Control/ Display   | Mechanical  | Mechanical  |
| Number of Door          | 1           | 1           |
| Refrigerant             | R600a       | R600a       |
| Climate Type            | SN-T        | SN-T        |
| <b>Dimensions</b>       |             |             |
| Net(W × D × H)(mm)      | 801x560x850 | 801x560x850 |
| Weight(Net/ Gross Kg)   | 31/33       | 31/33       |

## Chest Freezer



| Catalogue Model         | FC180SH     | FC120SH     |
|-------------------------|-------------|-------------|
| <b>Net Capacity</b>     |             |             |
| Total                   | 142         | 95          |
| Refrigerator            | 0           | 0           |
| Freezer                 | 142         | 95          |
| <b>General Features</b> |             |             |
| Temp Control/ Display   | Mechanical  | Mechanical  |
| Number of Door          | 1           | 1           |
| Refrigerant             | R600a       | R600a       |
| Climate Type            | SN-T        | SN-T        |
| <b>Dimensions</b>       |             |             |
| Net(W × D × H)(mm)      | 621x560x850 | 545x477x854 |
| Weight(Net/ Gross Kg)   | 28/31       | 26/28       |

## Beverage Cooler



| Catalogue Model             | FL-30FC      | FL-37FC      |
|-----------------------------|--------------|--------------|
| <b>Net Capacity</b>         |              |              |
| Total                       | 222          | 282          |
| Refrigerator                | 222          | 282          |
| Freezer                     | 0            | 0            |
| <b>General Features</b>     |              |              |
| Temp Control/ Display       | Mechanical   | Mechanical   |
| Defrosting                  | Manual       | Manual       |
| Refrigerant                 | R600a        | R600a        |
| Operating Temperature Range | 0 ~ 10°      | 0 ~ 10°      |
| Climate Type                | ST           | ST           |
| Casters/Wheels/Feet         | 4 Casters    | 4 Casters    |
| <b>Dimensions</b>           |              |              |
| Net(W × D × H)(mm)          | 540x575x1560 | 540x615x1740 |
| Weight(Net/ Gross Kg)       | 57/62        | 63/68        |

## Beverage Cooler



| Catalogue Model             | FL-42FC                       | FL-50FC                       |
|-----------------------------|-------------------------------|-------------------------------|
| <b>Net Capacity</b>         |                               |                               |
| Total                       | 320                           | 382                           |
| Refrigerator                | 320                           | 382                           |
| Freezer                     | 0                             | 0                             |
| <b>General Features</b>     |                               |                               |
| Temp Control/ Display       | Mechanical                    | Mechanical                    |
| Defrosting                  | Manual                        | Manual                        |
| Refrigerant                 | R600a                         | R600a                         |
| Operating Temperature Range | 0~10°                         | 0~10°                         |
| Climate Type                | ST                            | ST                            |
| Casters/Wheels/Feet         | 2 Casters & 2 Adjustable Feet | 4 Casters & 2 Adjustable Feet |
| <b>Dimensions</b>           |                               |                               |
| Net(W × D × H)(mm)          | 600x675x1853                  | 600x650x2106                  |
| Weight(Net/ Gross Kg)       | 80/87                         | 83/90                         |

## Beverage Cooler



| Catalogue Model             | FL-99FC       |
|-----------------------------|---------------|
| <b>Net Capacity</b>         |               |
| Total                       | 758           |
| Refrigerator                | 758           |
| Freezer                     | 0             |
| <b>General Features</b>     |               |
| Temp Control/ Display       | Mechanical    |
| Defrosting                  | No Frost      |
| Refrigerant                 | R134a         |
| Operating Temperature Range | 0~10°         |
| Climate Type                | ST            |
| Casters/Wheels/Feet         | 5 Casters     |
| <b>Dimensions</b>           |               |
| Net(W × D × H)(mm)          | 1010x710x2060 |
| Weight(Net/ Gross Kg)       | 170/182       |

Hisense

# WASHING MACHINE

COLLECTION 2023 – 2024





# FRONT LOAD WASHING MACHINE

Smart washing  
Easy living

ConnectLife, Steam, and Hygiene Guard can let your washing become much more smarter and convenient.





## HYGIENE GUARD+

The newest Series 5S washer is designed around hygiene. With a wide range of features like jet wash, sterile rubber seal, anti-bacterial soapbox and automatic drum clean, your laundry will always be clean and germ-free.



## STEAM

The high-temperature steam fully-penetrates the clothes – helping to eliminate 99.99%\* of Escherichia coli and Staphylococcus aureus. So you can guarantee your clothes are not just clean from dirt, but bacteria too.



## JET WASH

The top-mounted jet drastically improves your wash at every step. The jet makes help remove stains from your favorite clothes and the detergent will be evenly spread to give you the perfect washing results.

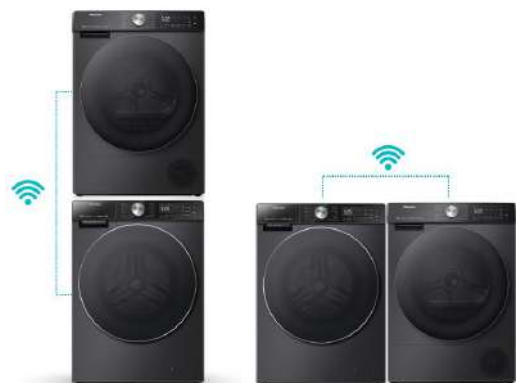

## CONNECTLIFE

ConnectLife supports you in any location in anytime to better arrange your laundries. The Wi-Fi Connectivity brings you various options to properly start your programme and receives notification messages from your phone.

## SERIES 5S



ConnectLife Addition Cycles



Hygiene Guard Steam Durable Inverter

| MODEL                        | WF5S1243BT    |
|------------------------------|---------------|
| <b>Basic Data</b>            |               |
| Washing Capacity (kg)        | 12            |
| Max Spin Speed Option. (rpm) | 1400          |
| Voltage (V) / Frequency (Hz) | 220-240/50    |
| Option Colors                | Premium black |
| Motor                        | BLDC          |
| NO. of Programs              | 14+5          |
| <b>Performance</b>           |               |
| Energy Efficiency Class      | A+++          |
| <b>Dimensions</b>            |               |
| Net (W×D×H) (mm)             | 595×660×845   |
| Loading Capacity (40H.C.)    | 159           |

## SERIES 3 3Q



ConnectLife Jet Wash Durable Inverter



Steam

| MODEL                        | WF3Q1043BT    |
|------------------------------|---------------|
| <b>Basic Data</b>            |               |
| Washing Capacity (kg)        | 10            |
| Max Spin Speed (rpm)         | 1400          |
| Voltage (V) / Frequency (Hz) | 220-240/50    |
| Option Colors                | Titanium Gray |
| Motor                        | BLDC          |
| No. of Programs              | 15            |
| <b>Performance</b>           |               |
| Energy Efficiency Class      | A+++          |
| <b>Dimensions</b>            |               |
| Net (W×D×H) (mm)             | 595×610×845   |
| Loading Capacity (40H.C.)    | 159           |

## SERIES 1Q



Steam



Durable Inverter



Quick Wash

| Model                        | WFQP7012T     |
|------------------------------|---------------|
| <b>Basic Data</b>            |               |
| Washing Capacity (kg)        | 7             |
| Max Spin Speed Option. (rpm) | 1200          |
| Voltage (V) / Frequency (Hz) | 220-240/50    |
| Option Colors                | Titanium Gray |
| Motor                        | BLDC          |
| NO. of Programs              | 15            |
| <b>Performance</b>           |               |
| Energy Efficiency Class      | A+++          |
| <b>Dimensions</b>            |               |
| Net (W×D×H) (mm)             | 595×460×845   |
| Loading Capacity (40H.C.)    | 230           |

## SERIES 1Q



Steam



Durable Inverter



Quick Wash

| Model                        | WFQP8014T     |
|------------------------------|---------------|
| <b>Basic Data</b>            |               |
| Washing Capacity (kg)        | 8             |
| Max Spin Speed Option. (rpm) | 1400          |
| Voltage (V) / Frequency (Hz) | 220-240/50    |
| Option Colors                | Titanium Gray |
| Motor                        | BLDC          |
| NO. of Programs              | 15            |
| <b>Performance</b>           |               |
| Energy Efficiency Class      | A+++          |
| <b>Dimensions</b>            |               |
| Net (W×D×H) (mm)             | 595×540×845   |
| Loading Capacity (40H.C.)    | 212           |

## SERIES 1V



Steam



Quick Wash

| Model                        | WFVB6010MS  |
|------------------------------|-------------|
| <b>Basic Data</b>            |             |
| Washing Capacity (kg)        | 6           |
| Max Spin Speed Option. (rpm) | 1000        |
| Voltage (V) / Frequency (Hz) | 220-240/50  |
| Option Colors                | Sliver      |
| Motor                        | UM          |
| NO. of Programs              | 15          |
| <b>Performance</b>           |             |
| Energy Efficiency Class      | A++         |
| <b>Dimensions</b>            |             |
| Net (W×D×H) (mm)             | 595×460×845 |
| Loading Capacity (40H.C.)    | 249         |



# FRONT LOAD TUMBLE DRYER

Smart drying  
Easy living

Hisense's dryer brings a better drying experience. ConnectLife, Intelligent TFT Display, and Self-cleaning Condenser can let your drying become much more smarter and convenient.



## POWER STEAM

Before your washing cycle starts, steam is released from the top of the drum, helping to remove wrinkles and odor. The right amount of water is then added, making your shirts smoother – without any ironing required.

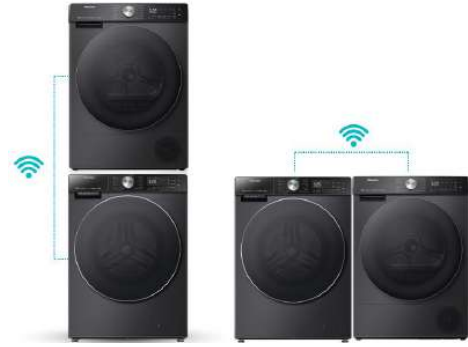

## CONNECTLIFE

ConnectLife supports you in any location in anytime to better arrange your laundries. The Wi-Fi Connectivity brings you various options to properly start your programme and receives notification messages from your phone.



## ALLERGY CARE

The sterilization drying uses high temperature hot air, which can remove 99.99% of Escherichia coli and Staphylococcus aureus without affecting the drying effect, leaving clothes dry and clean. No need to worry about allergy anymore.



## SELF-CLEANING CONDENSER

With the Hisense self-clean function, the dryer will automatically clean and remove any lint left in the condenser, keeping your dryer clean and in a tip-top shape.

## SERIES 5 5S



ConnectLife



Ion Refresh



Smart Dry



AI Dry



Allergy Care



Inverter

| MODEL                        | DH5S102BB     |
|------------------------------|---------------|
| <b>Basic Data</b>            |               |
| Drying Capacity              | 10            |
| Voltage (V) / Frequency (Hz) | 220-240/50    |
| Option Colors                | Premium Black |
| Drying mode                  | Heat Pump     |
| No. of Programs              | 14            |
| <b>Performance</b>           |               |
| Energy Efficiency Class      | A+++          |
| <b>Dimensions</b>            |               |
| Net (WxDxH) (mm)             | 595x660x845   |
| Loading Capacity (40H.C.)    | 159           |

## SERIES IW



| MODEL                        | DV1W801US   |
|------------------------------|-------------|
| <b>Basic Data</b>            |             |
| Drying Capacity              | 8           |
| Voltage (V) / Frequency (Hz) | 220-240/50  |
| Option Colors                | White       |
| No. of Programs              | 12          |
| <b>Dimensions</b>            |             |
| Net (WxDxH) (mm)             | 555x598x845 |
| Loading Capacity (40H.C.)    | 215         |



# FRONT LOAD WASHER & DRYER

Smart washing  
Easy living

Hisense's 2 in 1 washer & dryer brings a better washing experience. ConnectLife, Auto Dosing and Slim Display can let your washing become much more smarter and convenient.





## WASHER & DRYER 2 IN 1

Hisense's 2in1 solution allows you to wash and dry your laundry in just one appliance. Get the same quality results in half the space and with less work. This greatly improves the convenience of washing and drying clothes.



### ENERGY MONITORING

Monitor your energy usage via ConnectLife APP. See how much electricity and water you've used per week, month and even year, and check estimated costs! By utilising this data, you can determine the best time to do your laundry to save both energy and money.



### SMART ASSIST

By choosing the fabrics type, color, dirt level and any other stain, the washing machine will wash your clothes with a perfect combination of the right temperature, time, and water. Your clothes will always be in top shape.



### SMART CONTROL

Smartly control your washer & dryer, including start, pause and various operations thanks to ConnectLife. Accessing and controlling your appliance is just a tap away, wherever you are.



## HYGIENE GUARD

Hisense's product can remove bacteria through drum clean and soapbox clean, and the Pure Jet function can wash away the stains on the door and bellow. The bellow here is also made of sterile material.



## AUTO DOSING

Your washing machine will automatically choose the precise detergent or softener dosage according to the weight of clothes. Better still, this machine can store up to 24 loads at one time - about a month without adding it again\*.

\*Based on the average of 6 loads per week / 5kg load / Medium soil level. Actual results may vary depending on individual use, the washing load and settings.



## ALLERGY STEAM

At the beginning of washing cycle, the Allergy Steam program releases penetrating steam that can eliminate 99.99% allergens and other microbes while keeping your favourite clothes clean and protect your skin.



## STEAM REFRESH

Freshen up your laundry with the power of steam. The combination of steam and rotation removes unpleasant odors while softening your clothes without the need for a washing cycle, saving you water, time, and energy.

## SERIES 5S

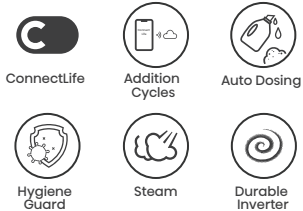

| Model                        | WD5S1245BB    |
|------------------------------|---------------|
| <b>Basic Data</b>            |               |
| Washing Capacity (kg)        | 12            |
| Drying Capacity              | 8             |
| Max Spin Speed Option. (rpm) | 1400          |
| Voltage (V) / Frequency (Hz) | 220~240/50    |
| Option Colors                | Premium Black |
| Motor                        | BLDC          |
| NO. of Programs              | 14+5          |
| <b>Performance</b>           |               |
| Energy Efficiency Class      | A             |
| <b>Dimensions</b>            |               |
| Net (WxDxH) (mm)             | 595×660×845   |
| Loading Capacity (40H.C.)    | 159           |

## SERIES 3 3Q



| MODEL                        | WD3Q1043BT    | WD3Q8043BT    |
|------------------------------|---------------|---------------|
| <b>Basic Data</b>            |               |               |
| Washing Capacity (kg)        | 10            | 8             |
| Drying Capacity              | 6             | 5             |
| Max Spin Speed (rpm)         | 1400          | 1400          |
| Voltage (V) / Frequency (Hz) | 220-240/50    | 220-240/50    |
| Option Colors                | Titanium Gray | Titanium Gray |
| Motor                        | BLDC          | BLDC          |
| No. of Programs              | 15            | 15            |
| <b>Performance</b>           |               |               |
| Energy Efficiency Class      | A             | A             |
| <b>Dimensions</b>            |               |               |
| Net (WxDxH) (mm)             | 595×660×845   | 595×540×850   |
| Loading Capacity (40H.C.)    | 159           | 212           |



# TOP LOAD WASHING MACHINE

Smart washing  
Easy living

With features that enable you to reliably achieve perfect washing results quickly, intuitively, silently and efficiently without damaging garments, Hisense's Top Loader embodies the elegance, gentleness and intensity of a mountain stream.



## SMART ASSIST

Just choose your clothes style, color, dirty level, fabric, and the washing machine will do the rest for you.

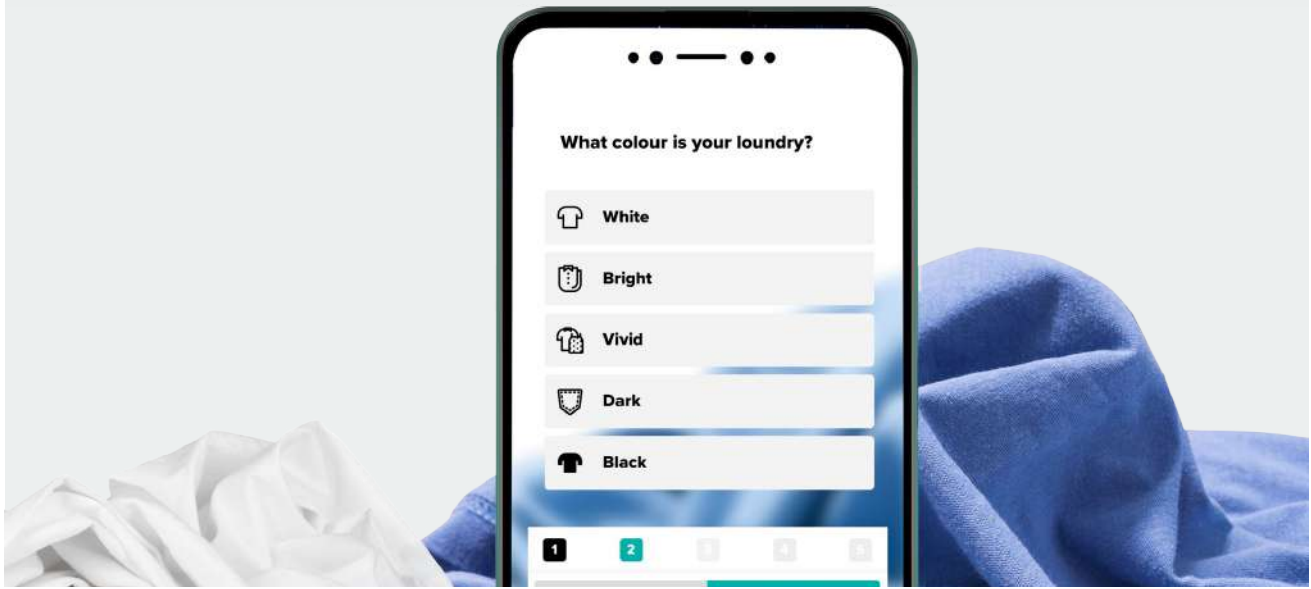

## SMART CONTROL

Smartly control your washing machine, including start, pause and various operations thanks to ConnectLife. Accessing and controlling your appliance is just a tap away, wherever you are.

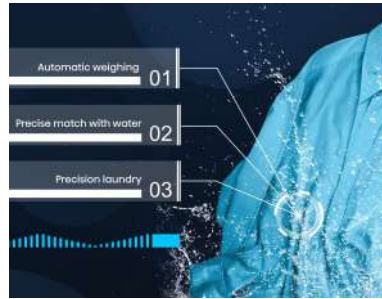

## SMART FUZZY

Enjoy precise laundry with Smart Fuzzy Control technology. The washer can weigh the laundry automatically and match the water levels accordingly. It makes washing much more convenient.



## DD INVERTER

Hisense' s direct drive technology uses frictionless mechanisms, which means your motor will work better without wasting more energy and vibrating less. This means it will last longer and work so quietly, even a baby could sleep next to it.



## TIDE WASH

With faster rotation speed and shorter suspend time, Hisense top-load washer provides more powerful water splash forces detergent deep into your clothes for a thorough wash in less time.



## REAR CONTROL

The Rear Control Panel offers a brand new appearance to Hisense top-load washer, which is more in line with the user's usage habits. More importantly, the rear control panel is more secure and durable, preventing safety problems caused by water droplets on the panel.



## BUBBLE CLEAN

Hisense's Bubble Clean detergent box has a maze-like structure that facilitates dissolving and activation of the detergent, generating the bubbles that penetrate deep into the fabric fibers to remove stains.



## MEGA CAPACITY

A bigger tub that allows you to do more laundry at once, satisfying your laundry need for whole family. This saves you time, energy and water, that would otherwise be wasted.

## SERIES 5T

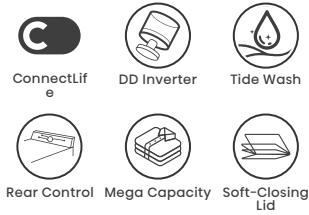

| Model                        | WT5T2025DB       |
|------------------------------|------------------|
| <b>Basic Data</b>            |                  |
| Washing Capacity (kg)        | 20               |
| Voltage (V) / Frequency (Hz) | 220~240/50       |
| Water Inlet / Pump           | Double/with pump |
| Option Colors                | Premium Black    |
| Motor                        | DDM              |
| NO. of Programs              | 11+              |
| <b>Dimensions</b>            |                  |
| Net (W×D×H) (mm)             | 685×700×1145     |
| Loading Capacity (40H.C.)    | 96               |

## SERIES 3T



| Model                        | WT3T1723UT       |
|------------------------------|------------------|
| <b>Basic Data</b>            |                  |
| Washing Capacity (kg)        | 17               |
| Voltage (V) / Frequency (Hz) | 220~240/50       |
| Water Inlet / Pump           | Double/with pump |
| Option Colors                | Premium Black    |
| Motor                        | UM               |
| NO. of Programs              | 12               |
| <b>Dimensions</b>            |                  |
| Net (W×D×H) (mm)             | 685×700×1120     |
| Loading Capacity (40H.C.)    | 96               |

## SERIES 3J



| Model                        | WTJA1112T        | WTJA802T         |
|------------------------------|------------------|------------------|
| <b>Basic Data</b>            |                  |                  |
| Washing Capacity (kg)        | 11               | 8                |
| Voltage (V) / Frequency (Hz) | 220~240/50       | 220~240/50       |
| Water Inlet / Pump           | Double/with pump | Double/with pump |
| Option Colors                | Titanium Gray    | Titanium Gray    |
| Motor                        | UM               | UM               |
| NO. of Programs              | 10               | 10               |
| <b>Dimensions</b>            |                  |                  |
| Net (W×D×H) (mm)             | 550×604×969      | 532×532×920      |
| Loading Capacity (40H.C.)    | 147              | 208              |



# TWIN-TUB WASHING MACHINE

Enjoy Easier Life

If you need Twin-tub semi-auto washing machine, we can provide products, which have the classic functions, such as Fashion Design, Rust Proof Body, Transparent Lid and Air tub spin drying and so on. Simple functional design, extraordinary washing result.



## Twin-Tub Washing Machine



| Model                        | WSPA503     | WSQB753     | WSRB113     |
|------------------------------|-------------|-------------|-------------|
| Voltage (V) / Frequency (Hz) | 220-240/50  | 220-240/50  | 220-240/50  |
| Commercial capacity (kg)     | 5/3         | 7.5/5       | 11.0/6.5    |
| Net (WxDxH) (mm)             | 602x373x730 | 721x408x828 | 807x482x980 |
| Water Inlet Selector         | YES         | YES         | YES         |
| Magic filter                 | YES         | YES         | YES         |
| Motor Safeguard technology   | YES         | YES         | YES         |
| Powerful Pulsator            | YES         | YES         | YES         |



# MICROWAVE OVEN

## COLLECTION

2023 - 2024

# TAILORED COOKING

## To be your own chef

If you know exactly what you want to cook and how, simply choose between five microwave power levels, grill or grill combi, set the cooking time and start to cook!

## Multi-stage Cooking

You can cook in 2 stages by manually programming the steps of cooking process to ensure all food are cooked at the perfect temperature in different stages without stop.



## Time & Weight Defrost

This microwave features time and weight defrost options. Simply input the weight, the defrosting power and time will be adjusted automatically, perfectly keeping the original texture and flavor of ingredients.

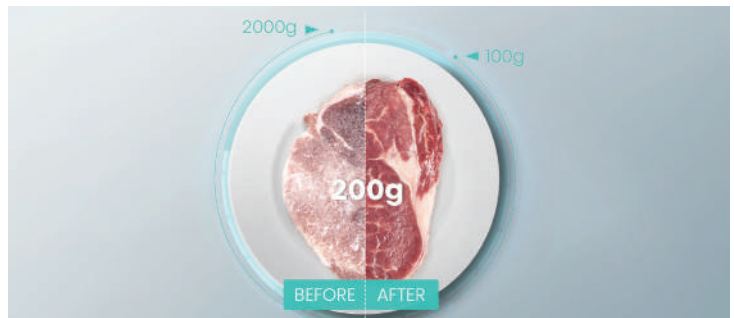

## Speedy Cooking

The microwave allows rapid heating at a single touch. With 100% microwave power, you can have your food cooked or reheated with much less waiting time.



## Combination Cooking

Combine the advantages of grill and microwaves to experience entirely new dimensions of cooking, which allow you to roast a smaller chunk of meat, bake a pizza and other dishes much faster.



## Child Safety Lock

The child safety lock gives you extra peace of mind and the highest level of safety while preventing young children from opening the door while in use.



# PRESET PROGRAMMES

 Cooking has never been so easy

The product comes with 6/7 pre-set auto cooking menus, such as pizza, popcorn, potato and more, allowing you to cook at a push of button.



## Tabletop Microwave Oven H20MOWS10/H20MOMS10



### Key Specifications:

|                         |                 |                    |      |
|-------------------------|-----------------|--------------------|------|
| Rated voltage/Frequency |                 | 230V~ 50Hz         |      |
| Microwave output power  |                 | 700W Microwave     |      |
| Frequency               |                 | 2450MHz            |      |
| Capacity                |                 | 20L                |      |
| Illumination            |                 | Incandescent 1x25W |      |
| Turntable size          |                 | Ø255mm             |      |
| Control                 | Mechanical knob | Power level        | 5    |
| Cooking timer           | 35min           | Function           | Solo |
| Defrost                 | Time defrost    | Child lock         | Yes  |

### Dimensions:

|                   |                                  |
|-------------------|----------------------------------|
| Product dimension | 440x328x259mm                    |
| Container loading | 20GP/40GP/40HQ: 648/1304/1470pcs |

## Tabletop Microwave Oven H20MOBS11



### Key Specifications:

|                         |                  |                    |      |
|-------------------------|------------------|--------------------|------|
| Rated voltage/Frequency |                  | 230V~ 50Hz         |      |
| Microwave output power  |                  | 700W Microwave     |      |
| Frequency               |                  | 2450MHz            |      |
| Capacity                |                  | 20L                |      |
| Illumination            |                  | Incandescent 1x25W |      |
| Turntable size          |                  | Ø255mm             |      |
| Control                 | Membrane digital | Power level        | 11   |
| Cooking timer           | 99.99mins        | Function           | Solo |
| Display                 | Blue LED         | Child lock         | Yes  |

### Dimensions:

|                   |                                  |
|-------------------|----------------------------------|
| Product dimension | 440x328x259mm                    |
| Container loading | 20GP/40GP/40HQ: 648/1304/1470pcs |

### Freestanding Microwave Oven H25MOMS7H



#### Key Specifications:

|                         |                     |                    |      |
|-------------------------|---------------------|--------------------|------|
| Rated voltage/Frequency |                     | 230V~ 50Hz         |      |
| Microwave output power  |                     | 900W Microwave     |      |
| Frequency               |                     | 2450MHz            |      |
| Capacity                |                     | 25L                |      |
| Illumination            |                     | Incandescent 1x25W |      |
| Turntable size          |                     | Ø 288mm            |      |
| Control                 | Membrane digital    | Power level        | 11   |
| Cooking timer           | 99.99mins           | Function           | Solo |
| Defrost                 | Time/Weight defrost | Child lock         | Yes  |

#### Dimensions:

|                   |                                |
|-------------------|--------------------------------|
| Product dimension | 485x410x293mm                  |
| Container loading | 20GP/40GP/40HQ: 306/630/735pcs |

### Freestanding Microwave Oven H36MOMMI



#### Key Specifications:

|                         |                  |                    |           |
|-------------------------|------------------|--------------------|-----------|
| Rated voltage/Frequency |                  | 230V~ 50Hz         |           |
| Microwave output power  |                  | 1000W Microwave    |           |
| Frequency               |                  | 2450MHz            |           |
| Capacity                |                  | 36L                |           |
| Illumination            |                  | Incandescent 1x25W |           |
| Turntable size          |                  | Ø 315mm            |           |
| Control                 | Membrane digital | Power level        | 10        |
| Cooking timer           | 95mins           | Function           | Solo      |
| Defrost                 | Yes              | Display            | Green LED |

#### Dimensions:

|                   |                                |
|-------------------|--------------------------------|
| Product dimension | 519x426x315mm                  |
| Container loading | 20GP/40GP/40HQ: 258/534/622pcs |



# AIR FRYER

---

# COLLECTION

2023 - 2024

# COOKING MENU

## Preset frying programs

You can use automatic settings for the preset programs, including meat, chicken wings, shrimps, fish, pizza, french fries, muffins or vegetables.

## Double Basket

Double basket allows you to prepare larger quantity of food at once. Double basket system ensures healthy cooking and easy to use and to clean manner.



## Airfry

Hot air is circling from top to bottom and back up to create perfect heat distribution. For crispy crust and moist in the middle with very little or no added oil.



## Touch Control

Clearly visible LED display with touch control panel is easy to use.





**H04AFBK1S1**  
Airfryer



**Key Specifications:**

|   |  |             |              |
|---|--|-------------|--------------|
| Voltage   | 120V/220-240V                            | Power       | 1400 W       |
| Frequency                                       | 50/60Hz                                  |             |              |
| Capacity  | 4.5L for the Pot, 3.5L for frying basket |             |              |
| Control   | LED digital control panel                |             |              |
| Timer   | 0-60 minutes                             |             |              |
| Detachable and non-stick surface of basket /Pot |  |             |              |
| Detachable frying basket                        |  |             |              |
| Temperature range                               | 80-200 °C                                |             |              |
| Cooking menu                                    | 9  | Loading Qty | 1412pcs/40HQ |
| Product dimension                               | 280 x 340 x 360 mm                       |             |              |

**H06AFBS1S3**  
Airfryer



**Key Specifications:**

|   |  |                   |                   |
|---|--|-------------------|-------------------|
| Voltage   | 120V/220-240V                            | Power             | 1700 W            |
| Frequency                                       | 50/60Hz                                  |                   |                   |
| Capacity  | 6.3L for the Pot, 5.0L for frying basket |                   |                   |
| Control   | LED digital control panel                |                   |                   |
| Timer   | 0-60 minutes timer                       |                   |                   |
| Detachable and non-stick surface of basket /Pot |  |                   |                   |
| Detachable frying basket                        |  |                   |                   |
| Temperature range                               | 80-200 °C                                | Loading Qty       | 1270pcs/40HQ      |
| Cooking menu                                    | 8  | Product dimension | 291 x 365 x 335mm |

**H09AFBK2S5**  
Airfryer



**Key Specifications:**

|                                  |                           |              |                     |
|----------------------------------|---------------------------|--------------|---------------------|
| Voltage                          | 120V/220-240V             | Power        | 1700W(1500W +1200W) |
| Frequency                        | 50/60Hz                   |              |                     |
| Capacity                         | 5.3L & 3.3L               |              |                     |
| Control                          | LED digital control panel |              |                     |
| Wide temperature range           | 80-200 °C                 |              |                     |
| Visible of bigger cooking drawer |                           |              |                     |
| Timer                            | 0-60min                   | Loading Qty  | 1015pcs/40HQ        |
| Cooking basket                   | 2                         | Product Size | 400 x 352 x 306mm   |

**H32AOSL1S5**  
Airfry Oven



**Key Specifications:**

|                        |   |             |             |
|------------------------|---|-------------|-------------|
| Voltage                | 220V-240V   | Power       | 1700W       |
| Frequency              | 50/60Hz   |             |             |
| Capacity               | 32L   |             |             |
| Control                | LED digital control panel                                     |             |             |
| Wide temperature range | 70-200 °C   |             |             |
| Function               | Airfry/Toast/Broil/Bake/Roast/Dehydrate/Ferment/Warm          |             |             |
| Menu                   | Pizza/Chips/Wings/Chicken/Shrimp/Bacon/Meat/Fish              |             |             |
| Airfry function        | 4 heating elements  |             |             |
| Accessories            | Chrome wire rack*1, al baking tray*1, basket *1, crumb tray*1 |             |             |
| Product size           | 504 x 392 x 334mm   | Loading Qty | 634pcs/40HQ |



# AIR CONDITIONER

## COLLECTION

2023 - 2024



# RESIDENTIAL AC

---

# SECURE

## Hi-AMP Control

One button, switch current, AC can continuously operate, without worrying about the current limit time. Don't worry about electricity limit, it can bring you durable comfort and cooling all the time.



## Electric Reactor

The independent reactor stabilizes the output voltage and ensures the stable operation of the outdoor circuit.

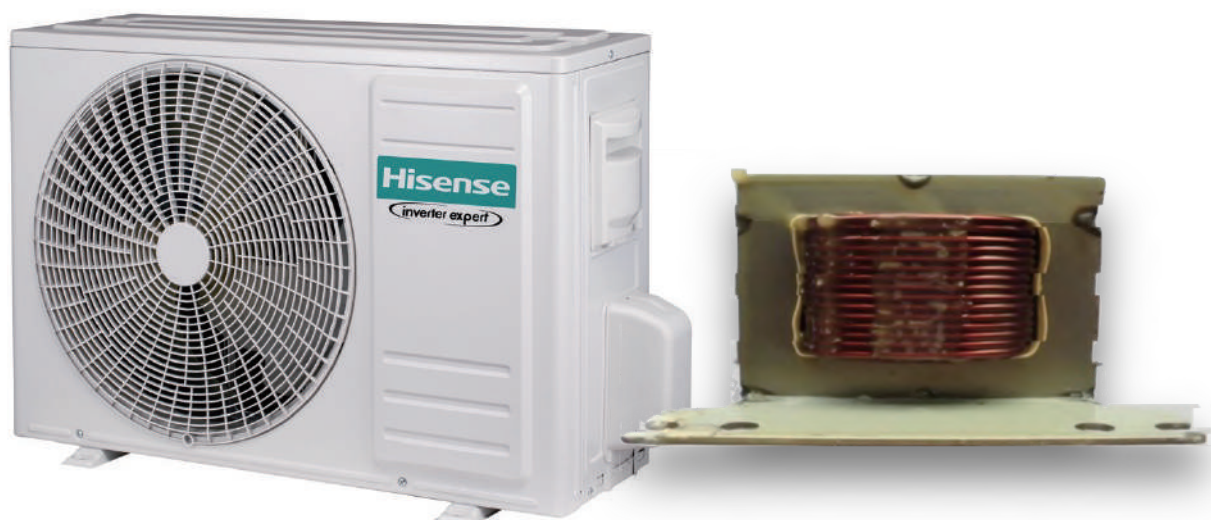

# COMFORT

## Give you a good mood

### Long Distance Airflow

By combining centralized air supply, big fans, and advanced DC inverter compressors, the AC system can cool large spaces up to 18 meters away. This means it can evenly distribute cool air throughout your home, making every part of your house comfortable and refreshing.



### Sleep Mode

Providing different sleep temperature care for family members, so you can enjoy a sound sleep in a comfortable environment.



# ENERGY SAVING

## Minimize power consumption while providing cooling comfort

### Twin Rotary DC Inverter Compressor

Reduce friction during operation, make rotation more stable, vibration less, and prevent the leakage of refrigerant gas during compression.



### ECO Mode

One button, AC immediately enters the energy-saving mode to minimize power consumption, which can save 30% power compared to ordinary inverter AC and saves 70% power compared to ON-OFF AC.



# HIGH RELIABILITY

## No fear of high temperature

### High Temperature Resistant PCB

The PCB board in the inverter air conditioner can still run normally under the high temperature of 85°C. High reliability, long life running.

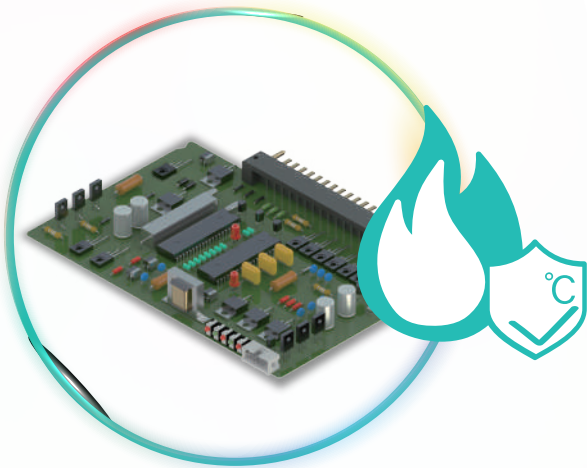

### Self Diagnosis & Automatic Protection

Enjoy the benefits of real-time monitoring and self-diagnosis, which includes displaying error codes in case of a malfunction. Additionally, our system offers an emergency power-down feature to prevent overloads.



### 3 Minutes Protection

The 3 minutes protection can avoid damages to the compressor and extend the compressor's life span.



### Anti-corrosive Golden Fin

The unique anticorrosive golden fin can withstand the salty air, rain and other corrosive elements. According to the salt spray test, the level of corrosion protection is significantly 3 to 4 times better than normal fin. It also has better hydrophilic, higher heat exchanging efficiency and more attractive than normal fin.

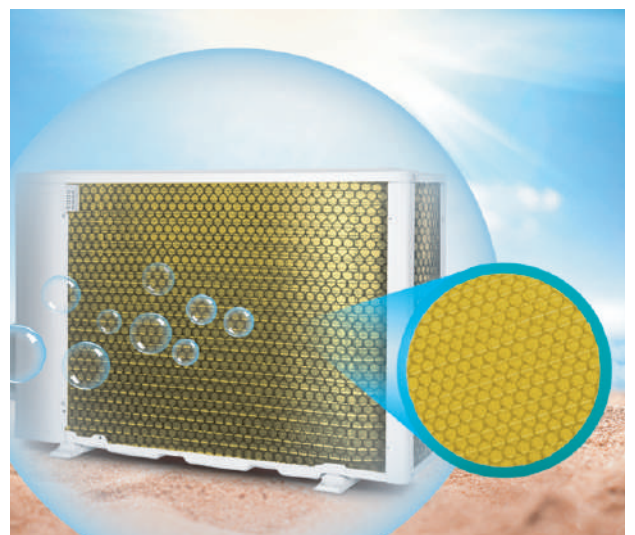

# TECHNOLOGY

Emphasis on independent innovation, focus on comfort

## HI-SMART

Advanced self-adaptive BLDC compressor driver technology makes the air conditioners run more quietly and more efficiently, and bring more comfortable experiences to the consumers.

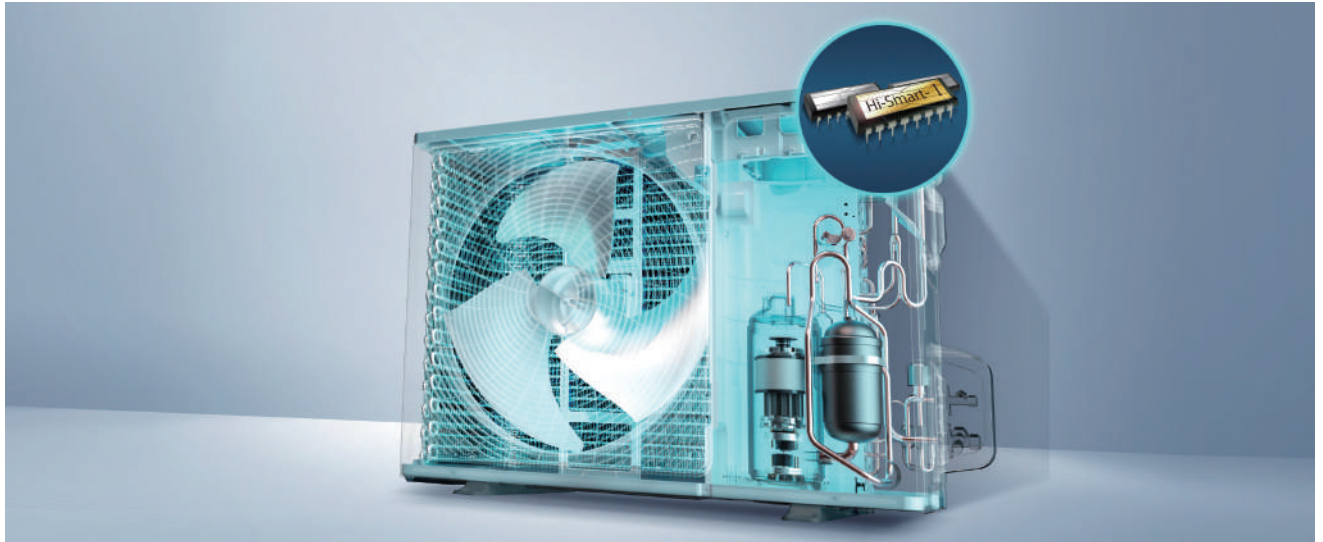

## QSD Rapid Frequency Conversion Startup Technology

Through our QSD rapid inverter startup technology, the compressor can quickly reach its maximum operating frequency, enabling rapid cooling. The dual-mode frequency conversion capability saves energy for both short-term and long-term use. This efficient power-saving mode ensures gentle cooling, suitable for the elderly and children to prevent catching a cold. Furthermore, our long-lasting energy-saving mode provides instant refreshment and cooling for those who are sensitive to heat.



# Elegance Series



| Hisense model                       |                           |         | AS-09CR4FYDTG       | AS-12CR4FVDTG00     | AS-18CR4FXATG00     |
|-------------------------------------|---------------------------|---------|---------------------|---------------------|---------------------|
| Power supply                        |                           | Ph-V-Hz | 220-240V~ 50Hz, 1Ph | 220-240V~ 50Hz, 1Ph | 220-240V~ 50Hz, 1Ph |
|                                     | Capacity                  | W       | 2800                | 3517                | 5275                |
|                                     | Annual Energy Consumption | KWh/yr  | 500                 | 605                 | 865                 |
| Cooling                             | Input                     | W       | 1000                | 1210                | 1730                |
|                                     | Rated current             | A       | 4.7                 | 5.4                 | 8.1                 |
|                                     | EER                       | W/W     | 2.8                 | 2.91                | 3.05                |
| Moisture Removal                    |                           | L/h     | 1.2                 | 1.2                 | 1.5                 |
| Max. input Consumption              |                           | W       | 1200                | 1700                | 2800                |
| Max. current                        |                           | A       | 6.4                 | 9.3                 | 16.8                |
| Indoor unit                         | Dimension(W*H*D)          | mm      | 880*275*207         | 880*275*207         | 1050*320*235        |
|                                     | Packing (W*H*D)           | mm      | 930*335*260         | 930*335*260         | 1118*392*318        |
|                                     | Net/Gross weight          | Kg      | 8.0/9.5             | 8.0/9.5             | 12.5/14.5           |
| Outdoor unit                        | Dimension(W*H*D)          | mm      | 660*482*240         | 715*482*240         | 810*585*280         |
|                                     | Packing (W*H*D)           | mm      | 785*530*315         | 830*530*315         | 940*630*385         |
|                                     | Net/Gross weight          | Kg      | 22/24.5             | 25/27               | 38/41               |
| Application area (Cooling Standard) |                           |         | 9~15                | 15~25               | 25~35               |
| Qty'per 20' /40' /40'HQ (no pipe)   |                           |         | 148/310/340         | 140/294/330         | 81/168/184          |
| Qty'per 20' /40' /40'HQ (with pipe) |                           |         | 134/286/322         | 135/282/318         | 81/168/184          |



# RELIABILITY

## Low Voltage(150V)

PFC control technology can make voltage compensation under low-voltage conditions, and the system can turn on or off PFC (power factor adjustment technology) according to voltage conditions, so as to realize low-voltage startup and efficient operation when voltage is stable. When voltage goes down to 150V, It can running stably used unique electronic components.

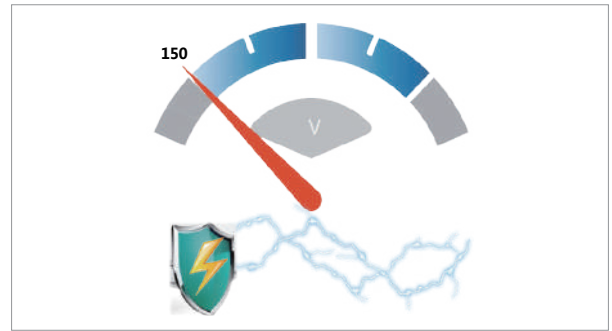

The AC can still run stably even when the voltage is low to 150V

## Super Mode

By pressing the "super" button, the air conditioner is not affected by the ambient temperature, and always runs at the maximum power and air volume to quickly reduce the indoor temperature.



## Fast Cooling

QSD rapid inverter startup technology is Industry No.1 CLOSED-LOOP BLDC Startup. Through QSD rapid inverter startup technology, compressor can reach the highest frequency in a short time and achieve fast cooling.



## Fire-Proof Electric Box

Use internal fireproof plastic case, prevent catch fire from any electric accident.

## Safety Protection Design

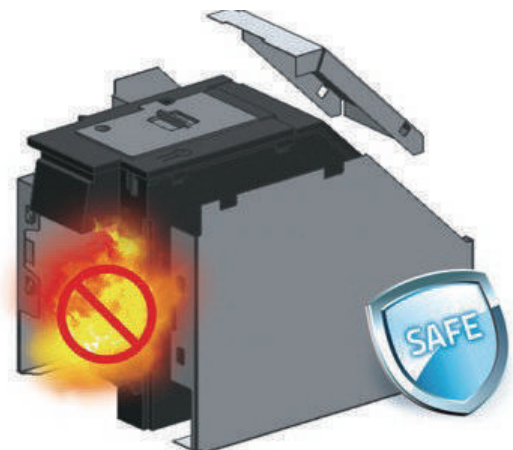

# Precious Series



| Hisense model                       |                           |         | AS-09TR4SYDDK03A    | AS-12TR4SYEDK04     | AS-18TR4SMADK01D    |
|-------------------------------------|---------------------------|---------|---------------------|---------------------|---------------------|
| Power supply                        |                           | Ph-V-Hz | 220-240V~ 50Hz, 1Ph | 220-240V~ 50Hz, 1Ph | 220-240V~ 50Hz, 1Ph |
|                                     | Capacity                  | W       | 2638(600~3500)      | 3700(1600~3900)     | 5100(2300~5400)     |
|                                     | Annual Energy Consumption | KWh/yr  | 450                 | 615                 | 890                 |
| Cooling                             | Input                     | W       | 900(200~1450)       | 1230(400~1550)      | 1780(580~2100)      |
|                                     | Rated current             | A       | 4(1.0~7.0)          | 5.5(2.0~7.5)        | 8(3.1~9.5)          |
|                                     | EER                       | W/W     | 2.93                | 3.01                | 2.87                |
| Moisture Removal                    |                           | L/h     | 0.8                 | 1.2                 | 2                   |
| Max. input Consumption              |                           | W       | 1450                | 1550                | 2300                |
| Max. current                        |                           | A       | 7                   | 7.5                 | 12.7                |
| Indoor unit                         | Dimension(W*H*D)          | mm      | 745×270×212         | 815×270×212         | 915×315×235         |
|                                     | Packing (W*H*D)           | mm      | 800×260×335         | 870×335×265         | 1000×390×315        |
|                                     | Net/Gross weight          | Kg      | 8/9.5               | 8.5/10.5            | 12/14.5             |
| Outdoor unit                        | Dimension(W*H*D)          | mm      | 660×240×482         | 660×482×240         | 780×540×260         |
|                                     | Packing (W*H*D)           | mm      | 785×340×530         | 785×530×340         | 910×600×360         |
|                                     | Net/Gross weight          | Kg      | 22/25               | 22/24               | 29/33               |
| Application area (Cooling Standard) |                           |         | 6-12                | 12-24               | 20-30               |
| Qty'per 20' /40' /40'HQ (no pipe)   |                           |         | 155/326/360         | 155/319/355         | 88/184/206          |
| Qty'per 20' /40' /40'HQ (with pipe) |                           |         | 146/308/343         | 143/296/330         | 88/184/206          |

# RELIABILITY

## VOLTAGE PROTECTION

Advanced high-voltage detection identifies rapid voltage fluctuations in advance, ensuring the efficient and stable operation of the control circuit.



## Long Distance Airflow

With long distance air supply, you can enjoy cool and comfortable temperatures anywhere in the room.



## Energy Saving

One button, switch current, AC can continuously operate, without worrying about the current limit time. Don't worry about electricity limit, it can bring you durable comfort and cooling all the time.



## Ultra wide frequency control(10-150HZ)

The compressor can operate in wide frequency, high frequency and high output for fast cooling; low frequency saves energy and electricity to maintain a stable temperature in the room.

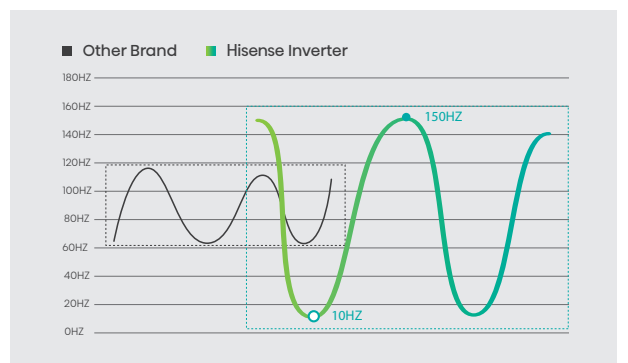



# SINGLE PACK

---

# PORTABLE AC

Y1N-X





### 360° Universal Wheel

With 360° Universal Wheel , enjoy coolness everywhere you like.



### R410A

Without destroying the ozone layer! (ODP=0) The greenhouse effect will be significantly reduced.

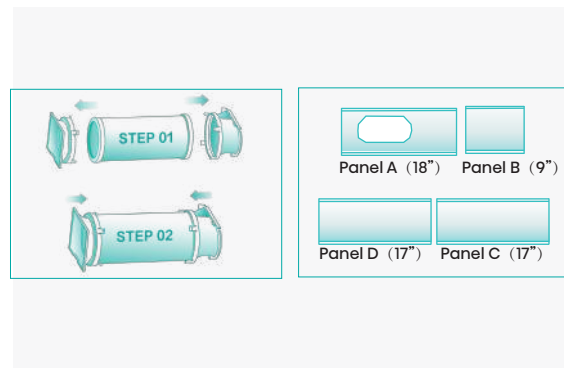

### Easy Installation

The pressure mounting window is very easy to install , and the installation structure is very stable.

| Manufacture Model                   |             | AP-12HR4SNPS00    |
|-------------------------------------|-------------|-------------------|
| Cooling Capacity                    | W           | 3,200             |
| Heating Capacity                    | W           | 2,800             |
| Power Input-Cooling                 | W           | 1160              |
| Power Input-Heating                 | W           | 1000              |
| Air Circulation                     | CMH Max     | 360               |
| Voltage, Frequency, Phase           |             | 220~240V~,50Hz,1P |
| Rated Curren                        | Cooling (A) | 5.5               |
|                                     | Heating (A) | 5.0               |
| LRA                                 | A           | 22.4              |
| Loading Capacity (40' HC Container) |             | 447               |
|                                     |             |                   |
|                                     |             |                   |

# IRAQ WINDOWS

## A-PANEL



## Simple And Stylish Design

Make life easier and more comfortable.



## Anion Generator

Anion can effectively eliminate bacteria, mold, virus and airborne dust, and improve the vital capacity of human being.

Hisense air purifier can release high-concentration anion, take the rainforest home.

## Air Quality Indicator

Digital particle concentration display, fresh air could be visible.

**Green-good**  
Dust≤35mg/m<sup>3</sup>



**Yellow-normal**  
35< Dust≤75

**Orange-little bad**  
75< Dust≤115

**Red-bad**  
115< Dust

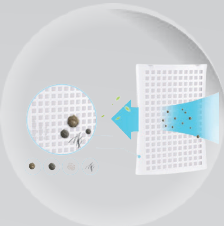

**P-CADR: 260 m<sup>3</sup>/h**

### Primary filtration+ HEPA 11 filter



**Primary filtration** : Dust、Particles、Filament、Hair  
**HEPA 11 filter** : Micron particles

### Release high-concentration anion

Keep the air fresh and clean

| Model                               | AE-15K4AF1    | AE-23R4AF     |
|-------------------------------------|---------------|---------------|
| Power Supply                        | 220V, 50Hz    | 220V, 50Hz    |
| Power Consumption                   | 52            | 48            |
| P-CADR/m <sup>3</sup> /h(CFM)       | 260(152)      | 400(235)      |
| P-CCM                               | P2            | P4            |
| Net/Gross Weight/kg                 | 8.0/10.2      | 8.5/11.2      |
| Net Size (L*W*H)                    | 432*268*638mm | 432*268*638mm |
| Package size (L*W*H)                | 510*338*723mm | 510*338*723mm |
| HEPA                                | H11           | H12           |
| "HEPA filter particle level(in μm)" | 0.3           | 0.1           |
| Deodorization                       | NO            | Yes           |
| Formaldehyde                        | NO            | Yes           |
| Activated carbon                    | NO            | Yes           |



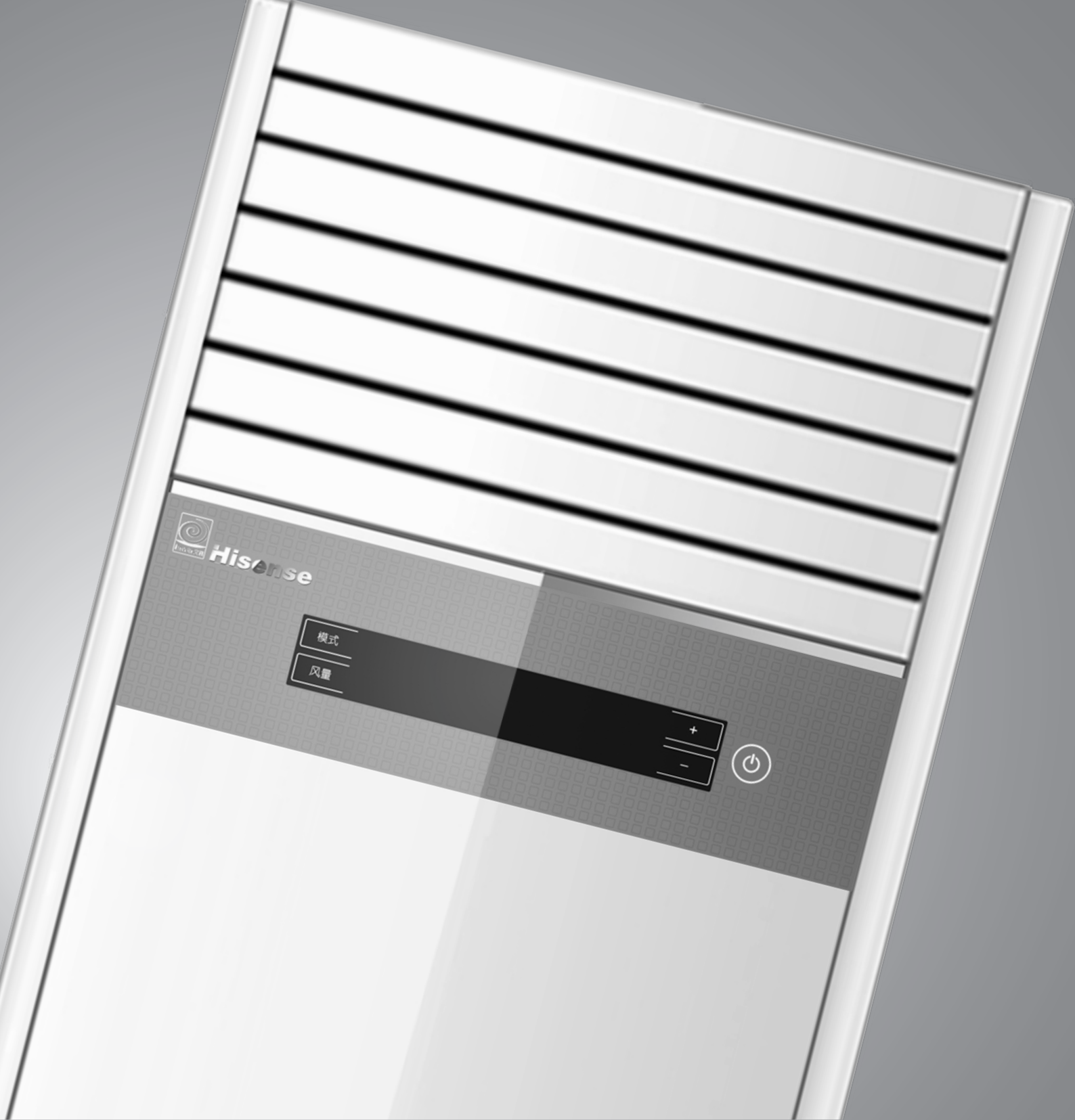

# LIGHT COMMERCIAL

---

# FLOOR STANDING



## Optional Healthy Filter

There are several optional health-oriented filters available. Activated Carbon Filter, Silver Ion Filter, 4-in-1 Filter etc.

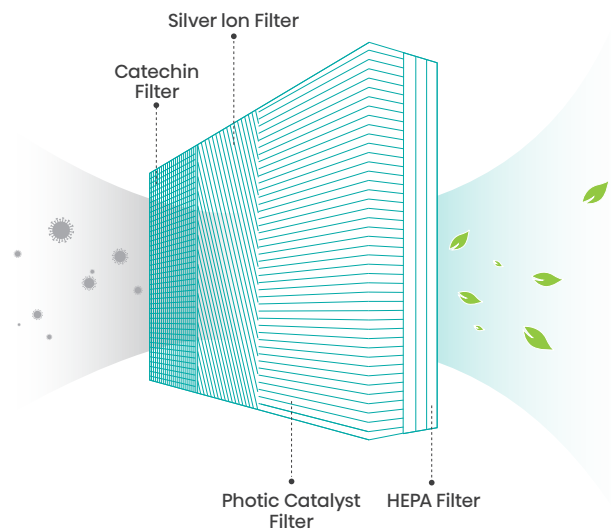

## 18m Long Distance Airflow

To meet the needs of large space, such as living room and meeting room.

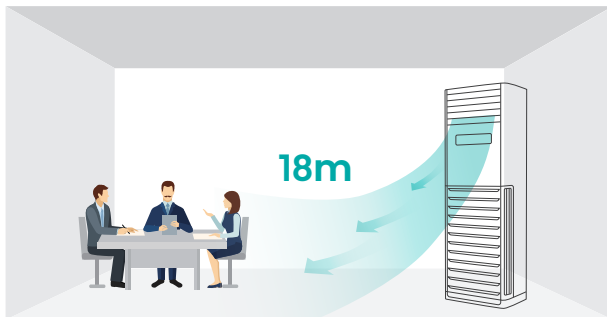

- Long-distance air supply up to 18m.



- Large air volume and fast cooling.

## 4D Air Flow

The air louvers which can swing vertically and horizontally helps to circulate air to every corner of the room.

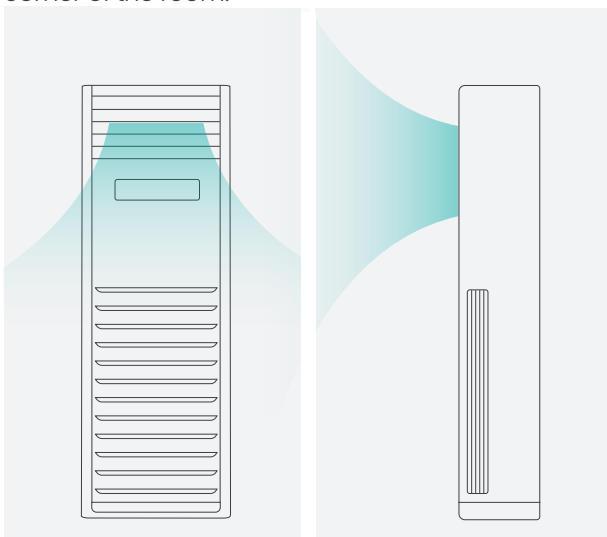

- Right and left

- Up and down

## Easy Clean Filter

The filter can be removed and cleaned easily.

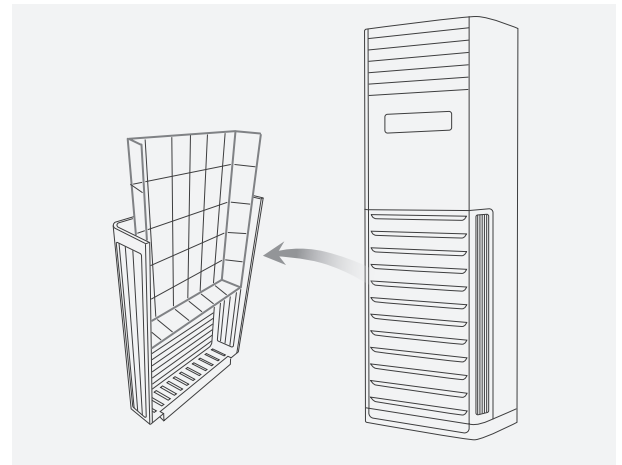

- Removing convenient

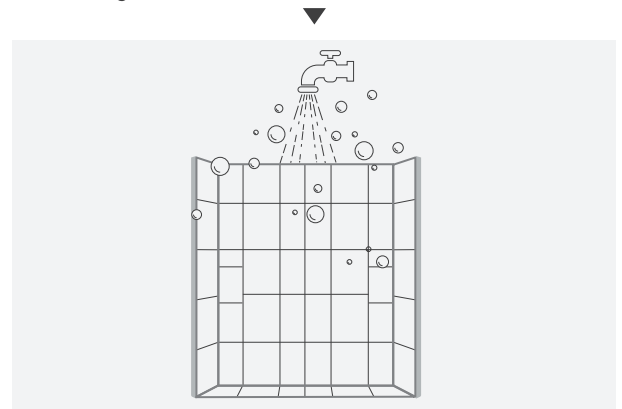

- Washable high definition filter

## Hi-Amp Control

Don't worry about electricity limit, it can bring you durable comfort and cooling all the time.

- When in Cooling mode, Press economy button for about 5 Seconds once to start Power control mode. (at low fan speed) Press the button about 5 seconds once again to stop it.
- When the appliance in the Power control mode, Press ECONOMY button once by once. Result: The operation modes changed in sequence.

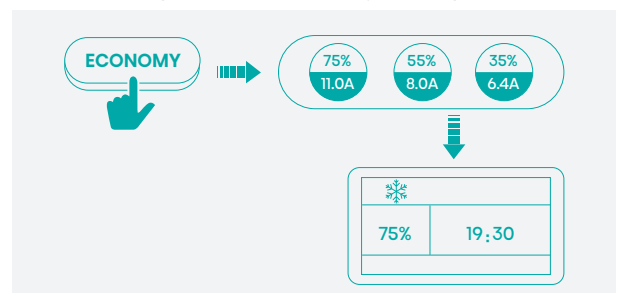

# ROUND FLOW CASSETTE



## Round Flow

Round air supply optimizes room airflow, ensuring that a comfortable airflow reaches every corner and that the temperature of the entire space is perfectly balanced.

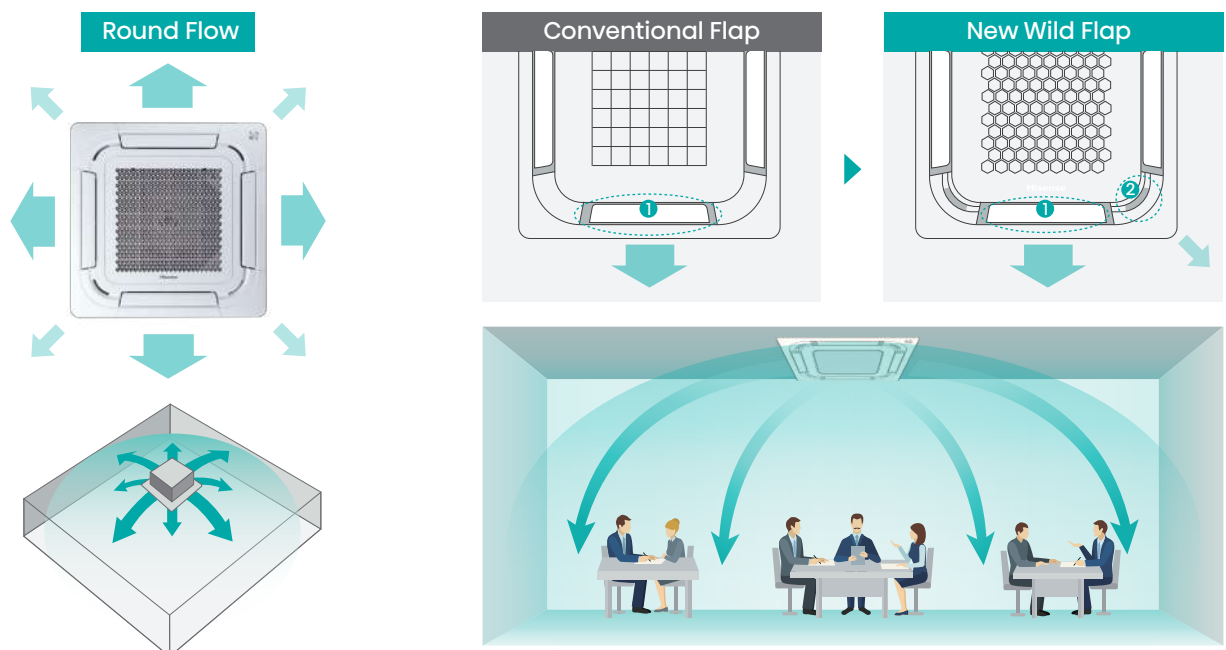

## Wide Airflow

The swing airflow can widely reach up to 88°.

Thanks to wide airflow, we can get the cooling ceiling airflow and strong heating airflow.

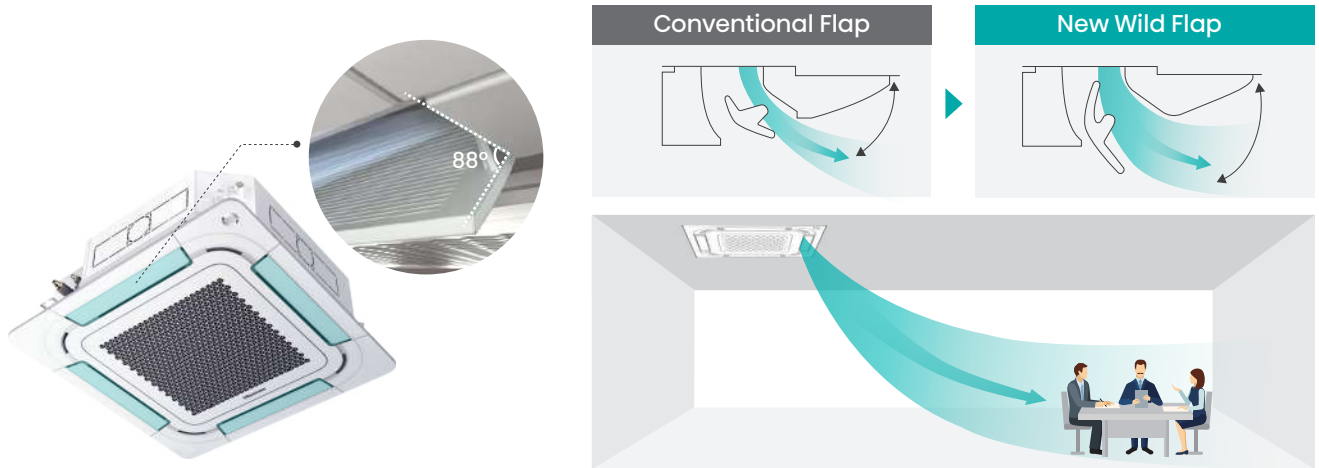

## High Efficiency Coil

The cassette adopts a G type design with a larger heat exchange area. Compared with traditional heat exchanger, it is more high-efficient and more power-saving.

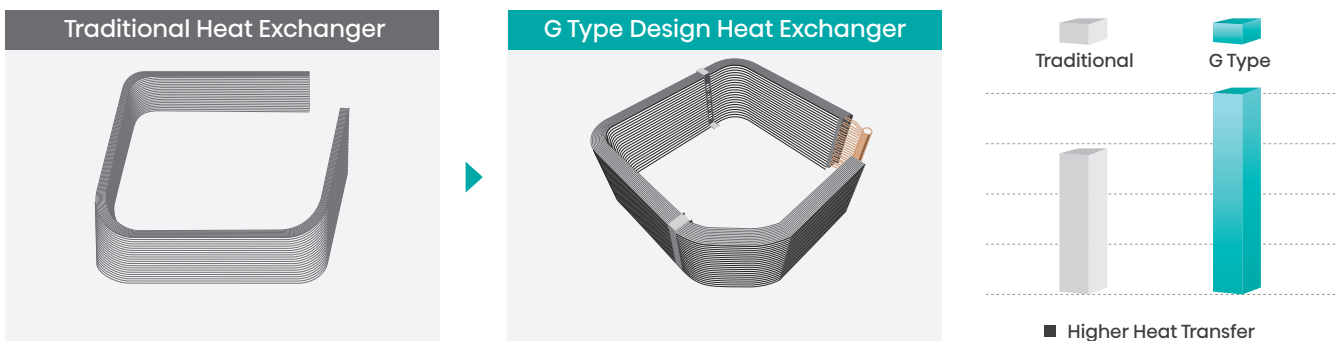

## Fresh Air Intake

The fresh air intake can introduce the outdoor fresh air into the room to improve the indoor air quality.

\* The fresh air volume cannot exceed 20% of total design air volume.

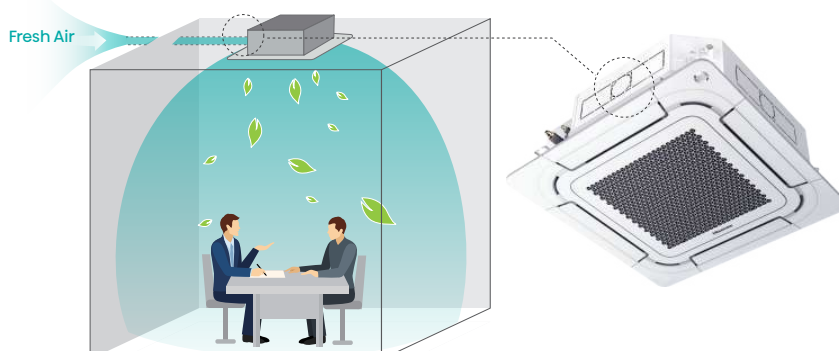

# DUCT



## ■ Slim Design

Slim duct unit, from 2.5kW to 7.0kW, have the height of only 190mm.

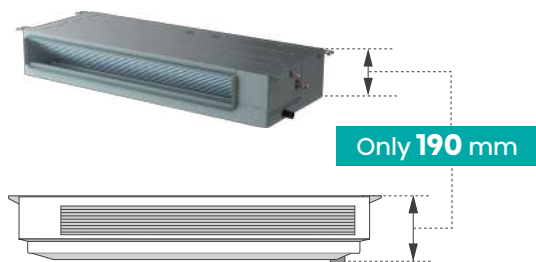

## ■ HSP Up to 250Pa

The external static pressure of ESP Duct unit up to a maximum of 150Pa makes it applicable for a wide range of building types.

250 Pa

## ■ Easy Installation

Air suction direction can be altered from rear to bottom, giving a choice between free use and connection to optional suction grilles.

\* The noise value of rear suction is 5dB lower than that of the bottom suction, so rear suction is recommended.

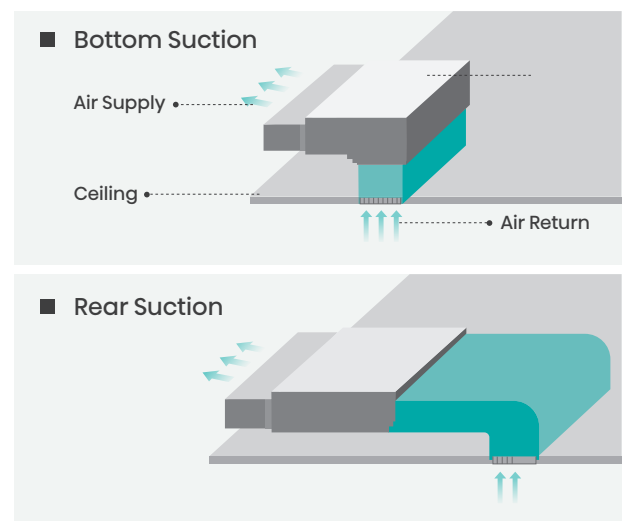

## Float Switch

The float switch can ensure the water is always under the safety level, even if the pump failed or the drain is blocked. This is double insurance for no water leakage disaster. Hisense duct units are all standard with float switches. The drain pan of Hisense is big enough for containing all the water returned from the drain pipe in suddenly power off.

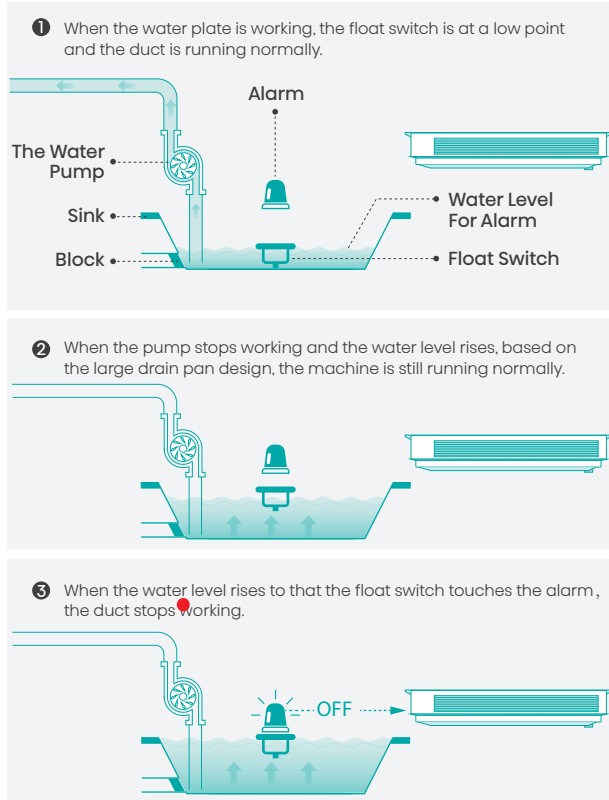

## Inner High Lift Pump

The maximum lift of Hisense high lift pump components can be as high as 1200mm.

\* In order to ensure smooth drainage in long-term operation, the recommended drainage height is <math>\leq 800\text{mm}</math>.

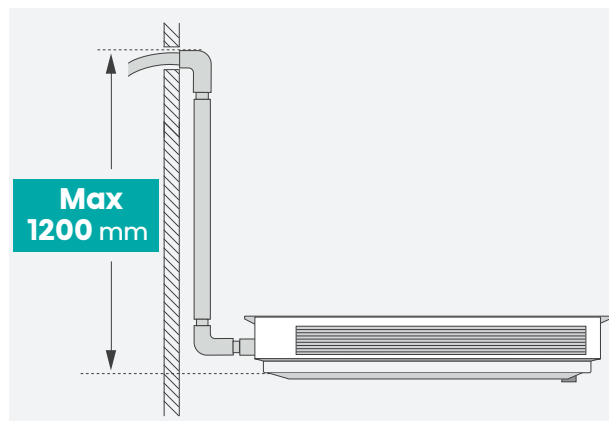

## 1Pa Adjustment

It is possible to adjust the ESP setting via wired controller. And the precision of 1 Pa can give the most accurate ESP setting in class.

\* YXE-C01U(E) is recommended to set the ESP parameter.(Parameter setting 17→10→from 1 to 250)

Warning: The slim duct with the capacity of 7.0kW(24K Btu/h) has the max ESP 40Pa. If we have to install the duct unit with a long duct, we have to choose the MSP duct of 7.0kW(24K Btu/h).

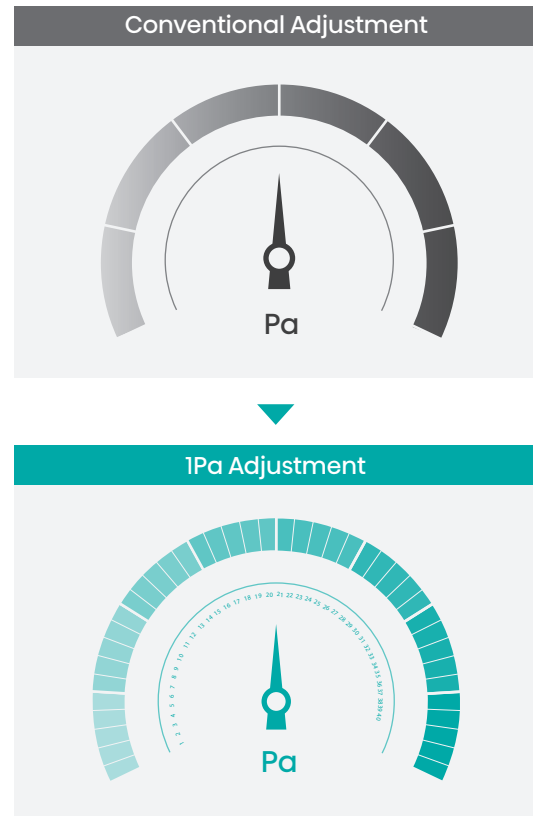

## Filter



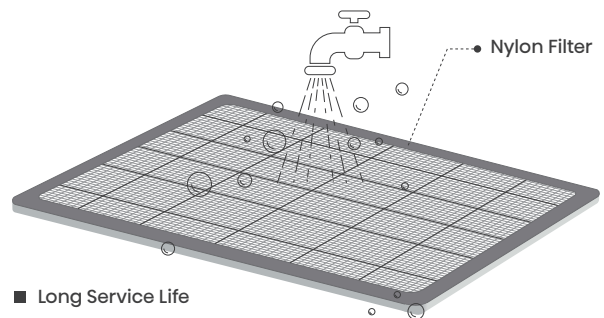





Hisense Duct units are all standard with nylon filter. The long-life filter can reduce the replacement and cleaning times. The filter is washable so that the dust can be easily washed off from the filter.



- Long Service Life
- Reduce The Replacement
- Reduce Cleaning Times
- Easy to Clean

# Floor Standing

Fixed Speed

-  I Feel
-  ON/OFF Function
-  Room Card Control
-  Fire Leakage Control
-  18m Long Distance Airflow
-  4D Air Flow
-  Wired Controller
-  Easy Clean Filter
-  Optional Healthy Filter



| Model                                |                          |                   | AUF-18CR4SMCPA3        | AUF-24CR4SJCPA3         | AUF-42CR6SDMPA1         | AUF-96CR6SDA           |
|--------------------------------------|--------------------------|-------------------|------------------------|-------------------------|-------------------------|------------------------|
| Power supply                         |                          | V-ph-Hz           | 220~240-1-50           | 220~240-1-50            | 380-415V~/3Ph/50Hz      | 380-415V 3N- 50Hz      |
| Cooling                              | Capacity T1              | Btu/h             | 18250                  | 24000                   | 42002                   | 95500                  |
|                                      | Capacity T1              | W                 | 5350                   | 7033                    | 12310                   | 28000                  |
|                                      | Input T1                 | W                 | 1875                   | 2315                    | 4100                    | 8750                   |
|                                      | Current T1               | A                 | 8.6                    | 11                      | 7.8                     | 14.9                   |
|                                      | EER T1                   | W/W               | 2.85                   | 3.04                    | 3.00                    | 3.20                   |
|                                      | EER T1                   | btu/h/w           | 9.73                   | 10.37                   | 10.24                   | 10.91                  |
| Indoor air flow Rated(Hi/Med/Lo)     |                          | m <sup>3</sup> /h | 1050/950/850           | 1050/950/850            | 1900                    | 4000                   |
| Indoor air flow Rated(Hi/Med/Lo)     |                          | CFM               | 617/559/500            | 617/559/500             | 1118                    | 2354                   |
| Indoor noise level (Hi/Med/Lo)       |                          | dB(A)             | 46                     | 46                      | 54                      | 60                     |
| Indoor unit                          | Dimension (WxHxD)        | mm                | 500x1760 x280          | 500x1760 x280           | 580x1870x380            | 1200x1890x340          |
|                                      | Packing(LxWxH)           | mm                | 610X410X1890           | 610X410X1890            | 690x2000x480            | 1302x437x2072          |
|                                      | Net/Gross weight         | kg                | 32.0/38.0              | 32.0/38.0               | 50/62                   | 118/142                |
| Outdoor noise level (sound pressure) |                          | dB(A)             | 56                     | 57                      | 59                      | 67                     |
| Outdoor unit                         | Dimension(WxDxH)         | mm                | 780x540x260            | 860x670x310             | 885x795x366             | 1280x908x700           |
|                                      | Packing(LxWxH)           | mm                | 910x370x610            | 990x450x730             | 1050x910x500            | 1300x1060x766          |
|                                      | Net/Gross weight         | kg                | 35.0/37.5              | 47.0/51.0               | 65/69                   | 168/193                |
| Ambient temperature                  | Type                     |                   | R410A                  | R410A                   | R410A                   | R410A                  |
|                                      | Charged volume           | kg                | 0.85                   | 1.6                     | 2.33                    | 3300+3300              |
| Design pressure                      |                          | MPa               | 4.8/1.6                | 4.8/1.6                 | 4.16/1.6                | 4.8/1.6                |
| Refrigerant piping                   | Liquid side/ Gas side    | mm(inch)          | Φ6.35/Φ12.7(1/4"/1/2") | Φ9.52/Φ15.88(3/8"/5/8") | 9.52(3/8")/Φ15.88(5/8") | 9.52(3/8")/19.05(3/4") |
|                                      | Max. pipe length         | m                 | 25                     | 30                      | 30                      | 50                     |
|                                      | Max. difference in level | m                 | 10                     | 20                      | 15                      | 30                     |
| Ambient temperature                  | Cooling                  | C                 | 15-48                  | 15-48                   | 16-43                   | 16-48                  |
|                                      | Heating                  | C                 | /                      | /                       | /                       | /                      |



# Cassette

Fixed Speed



WiFi Control



Compact Design



Room Card Control



Fire Leakage Control



Individual Airflow Control



High Ceiling



Fresh Air Intake



Silver Ion Filter



Humidity Sensor



| Model                                |                          |                   | AUC-18CR4SMAA3         | AUC-24CR4SJJA3          | AUC-42CR6SEHA           |
|--------------------------------------|--------------------------|-------------------|------------------------|-------------------------|-------------------------|
| Power supply                         |                          | V-ph-Hz           | 220~240-1-50           | 220~240-1-50            | 380-415V~/3Ph/50Hz      |
| Cooling                              | Capacity T1              | Btu/h             | 18000                  | 24000                   | 13000                   |
|                                      | Capacity T1              | W                 | 5200                   | 7033                    | 44356                   |
|                                      | Input T1                 | W                 | 1825                   | 2230                    | 4420                    |
|                                      | Current T1               | A                 | 8.5                    | 11                      | 8.0                     |
|                                      | EER T1                   | W/W               | 2.85                   | 3.15                    | 2.94                    |
|                                      | EER T1                   | btu/h/w           | 9.86                   | 10.76                   | 10.04                   |
| Indoor air flow Rated(Hi/Med/Lo)     |                          | m <sup>3</sup> /h | 800/700/600            | 1300/1200/1050          | 2000                    |
| Indoor air flow Rated(Hi/Med/Lo)     |                          | CFM               | 470/412/353            | 765/706/618             | 1176                    |
| Indoor noise level (Hi/Med/Lo)       |                          | dB(A)             | 49/47/45               | 45/42/40                | 52                      |
| Indoor unit                          | Dimension (WxHxD)        | mm                | 650×270×570            | 840×236×840             | 840×298×840             |
|                                      | Packing(LxWxH)           | mm                | 770×750×310            | 950×950×320             | 996×420×956             |
|                                      | Net/Gross weight         | kg                | 20.0/24.5              | 23.5/29.0               | 33/42                   |
| Outdoor noise level (sound pressure) |                          | dB(A)             | 56                     | 57                      | 58                      |
| Outdoor unit                         | Dimension(WxDxH)         | mm                | 780×260×540            | 860×310×670             | 950×1050×340            |
|                                      | Packing(LxWxH)           | mm                | 910×370×610            | 990×450×730             | 1110×460×1200           |
|                                      | Net/Gross weight         | kg                | 35.0/37.5              | 47.0/51.0               | 93/100                  |
| Refrigerant type/<br>Quantity        | Type                     |                   | R410A                  | R410A                   | R410A                   |
|                                      | Charged volume           | kg                | 0.85                   | 1.6                     | 2.40                    |
| Design pressure                      |                          | MPa               | 4.8/1.6                | 4.8/1.6                 | 4.16/1.6                |
| Refrigerant piping                   | Liquid side/ Gas side    | mm(inch)          | Φ6.35/Φ12.7(1/4"/1/2") | Φ9.52/Φ15.88(3/8"/5/8") | 9.52(3/8")/Φ19.05(3/4") |
|                                      | Max. pipe length         | m                 | 25                     | 30                      | 50                      |
|                                      | Max. difference in level | m                 | 10                     | 20                      | 15                      |
| Ambient temperature                  | Cooling                  | °C                | 15-48                  | 15-48                   | 16-43                   |
|                                      | Heating                  | °C                | /                      | /                       | /                       |

# Duct

## T1-HP-Fix Speed

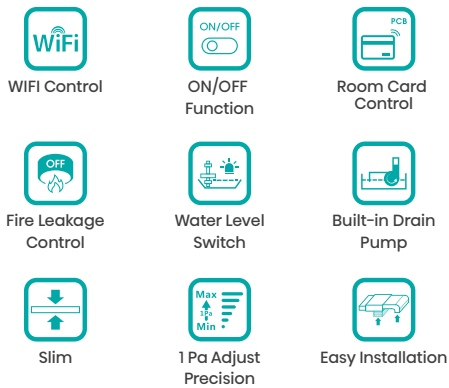

| Model                                |                          |                   | AUD-18CX4SMBL3            | AUD-24CX4SJLL3            |
|--------------------------------------|--------------------------|-------------------|---------------------------|---------------------------|
| Power supply                         |                          | V-ph-Hz           | 220 ~ 240-1-50            | 220 ~ 240-1-50            |
| Cooling                              | Capacity T1              | Btu/h             | 18000                     | 24000                     |
|                                      | Capacity T1              | W                 | 5275                      | 7033                      |
|                                      | Input T1                 | W                 | 1835                      | 2315                      |
|                                      | Current T1               | A                 | 8.5                       | 11                        |
|                                      | EER T1                   | W/W               | 2.87                      | 3.04                      |
|                                      | EER T1                   | btu/h/w           | 9.81                      | 10.37                     |
| Indoor air flow Rated(Hi/Med/Lo)     |                          | m <sup>3</sup> /h | 800/430/390               | 800/430/390               |
| Indoor air flow Rated(Hi/Med/Lo)     |                          | CFM               | 470/253/230               | 470/253/230               |
| ESP                                  | Rated                    | Pa                | 13                        | 50                        |
|                                      | Range                    | Pa                | 30                        | 80                        |
| Indoor noise level (Hi/Med/Lo)       |                          | dB(A)             | 41/34/33                  | 47/45/42                  |
| Indoor unit                          | Dimension (WxDxD)        | mm                | 910×190×447               | 900×270 ×720              |
|                                      | Packing(LxWxH)           | mm                | 1080×565×285              | 1170×870×340              |
|                                      | Net/Gross weight         | kg                | 19.0/22.5                 | 32.0/38.0                 |
| Outdoor noise level (sound pressure) |                          | dB(A)             | 56                        | 57                        |
| Outdoor unit                         | Dimension(WxDxH)         | mm                | 780×260×540               | 860×310×670               |
|                                      | Packing(LxWxH)           | mm                | 910×370×610               | 990×450×730               |
|                                      | Net/Gross weight         | kg                | 35.0/37.5                 | 47.0/51.0                 |
| Refrigerant type/ Quantity           | Type                     |                   | R410A                     | R410A                     |
|                                      | Charged volume           | kg                | 1                         | 2                         |
| Design pressure                      |                          | MPa               | 4.8/1.6                   | 4.8/1.6                   |
| Refrigerant piping                   | Liquid side/ Gas side    | mm(inch)          | Φ 6.35/ Φ 12.7(1/4"/1/2") | Φ 9.52/Φ 15.88(3/8"/5/8") |
|                                      | Max. pipe length         | m                 | 25                        | 30                        |
|                                      | Max. difference in level | m                 | 10                        | 20                        |
| Ambient temperature                  | Cooling                  | C                 | 15-48                     | 15-48                     |
|                                      | Heating                  | C                 | /                         | /                         |

# Duct

# T1-HP-Inverter

-  WiFi Control
-  ON/OFF Function
-  Room Card Control
-  Fire Leakage Control
-  Water Level Switch
-  Built-in Drain Pump
-  Slim
-  1 Pa Adjust Precision
-  Easy Installation



| Model                                |                          |                   | AUD-18UX4SSCL5       | AUD-24UX4SJLL5          | AUD-36UX4SNEH5          | AUD-48UX6SNEH5          | AUD-60UX6SNEH5          |
|--------------------------------------|--------------------------|-------------------|----------------------|-------------------------|-------------------------|-------------------------|-------------------------|
| Power supply                         | (Outdoor)                | V-ph-Hz           | 220~240-1-50         | 220~240-1-50            | 220~240-1-50            | 380~415-3-50            | 380~415-3-50            |
| Cooling                              | Capacity                 | W                 | 5000                 | 7000                    | 10000                   | 13500                   | 15500                   |
|                                      | Min - Max                | W                 | 1500~5800            | 2000~8200               | 2700~11800              | 4300~15000              | 4800~16200              |
|                                      | Input                    | W                 | 1535                 | 2215                    | 3575                    | 5400                    | 6330                    |
|                                      | Current                  | A                 | 6.7                  | 9.6                     | 15.5                    | 9.1                     | 10.7                    |
|                                      | EER                      | W/W               | 3.26                 | 3.16                    | 2.80                    | 2.50                    | 2.45                    |
| Heating                              | Capacity                 | W                 | 5500                 | 8000                    | 11000                   | 15500                   | 15500                   |
|                                      | Min - Max                | W                 | 1500~6300            | 2000~9200               | 2700~12500              | 3700~16500              | 4000~17500              |
|                                      | Input                    | W                 | 1480                 | 2300                    | 3045                    | 4725                    | 5345                    |
|                                      | Current                  | A                 | 6.4                  | 10.0                    | 13.2                    | 8.0                     | 9.0                     |
|                                      | COP                      | W/W               | 3.72                 | 3.48                    | 3.61                    | 3.28                    | 2.90                    |
| Indoor air flow Rated(Hi/Med/Lo)     |                          | m <sup>3</sup> /h | 900/840/780          | 1100/950/850            | 2200/2000/1700          | 2600/2500/2200          | 2600/2500/2200          |
| ESP                                  | Rated                    | Pa                | 25+10                | 25+10                   | 37+10                   | 50+10                   | 50+10                   |
|                                      | Range                    | Pa                | 0~50                 | 0~50                    | 0~200                   | 0~200                   | 0~200                   |
| Indoor noise level (Hi/Med/Lo)       |                          | dB(A)             | 41/37/33             | 42/38/34                | 55/53/51                | 56/54/52                | 57/55/53                |
| Indoor unit                          | Dimension (WxHxD)        | mm                | 1180x190x447         | 900x270x720             | 1400x300x800            | 1400x300x800            | 1400x300x800            |
|                                      | Packing(WxHxD)           | mm                | 1350x285x565         | 1170x870x340            | 1580x380x920            | 1580x380x920            | 1580x380x920            |
|                                      | Net/Gross weight         | kg                | 24.5/29.5            | 31/36                   | 53/59                   | 53/59                   | 53/59                   |
| Outdoor noise level (sound pressure) |                          | dB(A)             | 52                   | 53                      | 57                      | 58                      | 59                      |
| Outdoor unit                         | Dimension(WxHxD)         | mm                | 810x585x280          | 860x670x310             | 900x750x340             | 900x1170x320            | 900x1170x320            |
|                                      | Packing(WxHxD)           | mm                | 940x640x420          | 990x730x450             | 1040x830x460            | 970x1300x430            | 970x1300x430            |
|                                      | Net/Gross weight         | kg                | 36/40                | 47.5/51.0               | 55/59                   | 83/92                   | 93/102                  |
| Refrigerant type/ Quantity           | Type                     |                   | R410A                | R410A                   | R410A                   | R410A                   | R410A                   |
|                                      | Charged volume           | kg                | 1.50                 | 1.70                    | 2.40                    | 3.80                    | 4.00                    |
| Ambient Temperature                  |                          | MPa               | 4.15                 | 4.15/1.6                | 4.15/1.6                | 4.15/1.6                | 4.15/1.6                |
| Refrigerant piping                   | Liquid side/ Gas side    | mm(inch)          | 6.35/12.7(1/4"/1/2") | φ9.52/φ15.88(3/8"/5/8") | φ9.52/φ15.88(3/8"/5/8") | φ9.52/φ19.05(3/8"/3/4") | φ9.52/φ19.05(3/8"/3/4") |
|                                      | Max. pipe length         | m                 | 30                   | 30                      | 30                      | 50                      | 50                      |
|                                      | Max. difference in level | m                 | 15                   | 30                      | 30                      | 30                      | 30                      |
| Ambient temperature                  | Cooling                  | °C                | -15~48               | -15~48                  | -15~48                  | -15~48                  | -15~48                  |
|                                      | Heating                  | °C                | -10~24               | -10~24                  | -10~24                  | -10~24                  | -10~24                  |

## Floor Standing

Inverter



| Model                                |                          |                   | AUF-18TR4SMCPE         | AUF-24TR4SJCP E        |
|--------------------------------------|--------------------------|-------------------|------------------------|------------------------|
| Power supply                         |                          | V-ph-Hz           | 220 ~ 240-1-50         | 220 ~ 240-1-50         |
| Cooling                              | Capacity T1              | Btu/h             | 18100                  | 24000                  |
|                                      | Capacity T1              | W                 | 5300                   | 7033                   |
|                                      | Input T1                 | W                 | 1656                   | 2197                   |
|                                      | Current T1               | A                 | 7.3                    | 9.7                    |
|                                      | EER T1                   | W/W               | 3.20                   | 3.20                   |
|                                      | CSPF                     | W/W               | /                      | /                      |
| Indoor air flow Rated(Hi/Med/Lo)     |                          | m <sup>3</sup> /h | 1050/950/850           | 1050/950/850           |
| Indoor air flow Rated(Hi/Med/Lo)     |                          | CFM               | 617/559/500            | 617/559/500            |
| Indoor noise level (Hi/Med/Lo)       |                          | dB(A)             | 46/42/39               | 46/42/39               |
| Indoor unit                          | Dimension (WxHxD)        | mm                | 500×1760 ×280          | 500×1760 ×280          |
|                                      | Packing(LxWxH)           | mm                | 610X410X1890           | 610X410X1890           |
|                                      | Net/Gross weight         | kg                | 32.0/38.0              | 32.0/38.0              |
| Outdoor noise level (sound pressure) |                          | dB(A)             | 54                     | 57                     |
| Outdoor unit                         | Dimension(WxDxH)         | mm                | 780×540×260            | 860×670×310            |
|                                      | Packing(LxWxH)           | mm                | 910×370×610            | 990×450×730            |
|                                      | Net/Gross weight         | kg                | 29.0/31.5              | 40.0/44.0              |
| Refrigerant type/<br>Quantity        | Type                     |                   | R410A                  | R410A                  |
|                                      | Charged volume           | kg                | 0.95                   | 1.25                   |
| Design pressure                      |                          | MPa               | 4.5/1.5                | 4.5/1.5                |
| Refrigerant piping                   | Liquid side/ Gas side    | mm(inch)          | Φ6.35/Φ12.7(1/4"/1/2") | 9.52(3/8")/15.88(5/8") |
|                                      | Max. pipe length         | m                 | 25                     | 25                     |
|                                      | Max. difference in level | m                 | 10                     | 10                     |
| Ambient temperature                  | Cooling                  | °C                | 15-48                  | 15-48                  |
|                                      | Heating                  | °C                | /                      | /                      |

# FREE MATCH

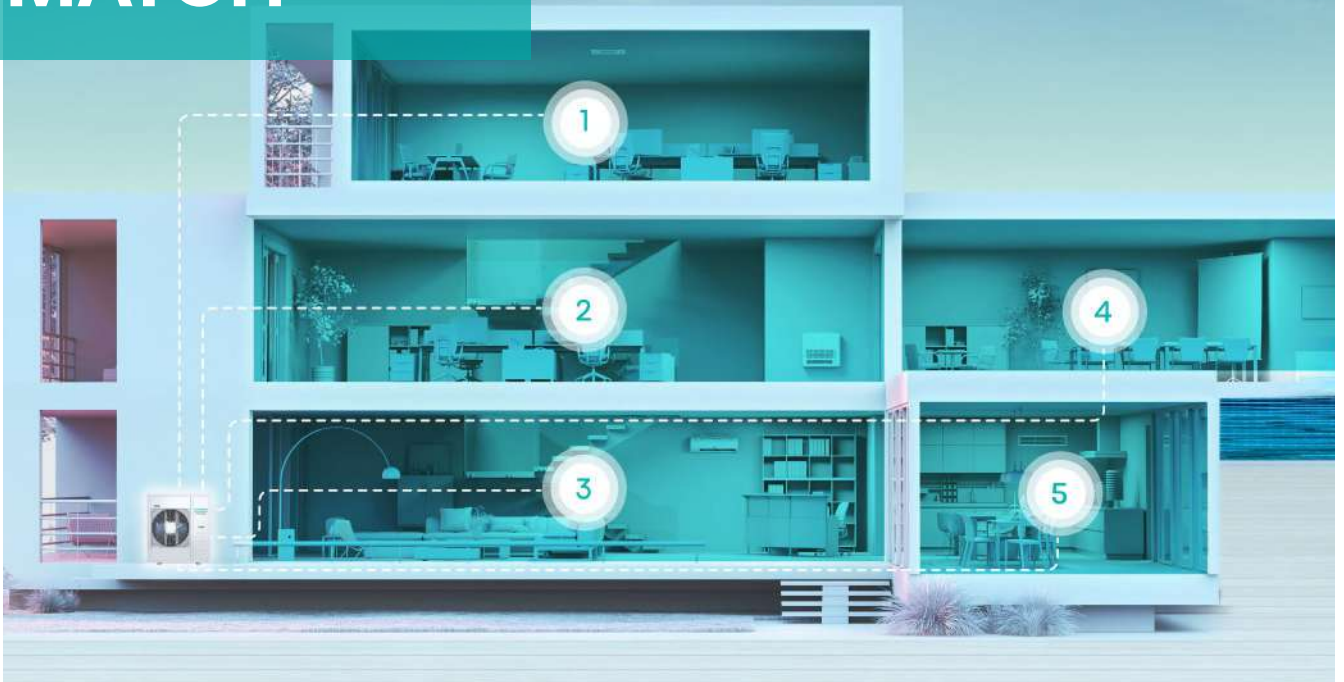

## Compact Design

Lighter and more compact units for easier and more flexible installation, as well as easier transportation with a higher potential volume of ACs per transportation unit.

Note: Hisense has the most compact 1 by 2 multi-split outdoor unit made in class.

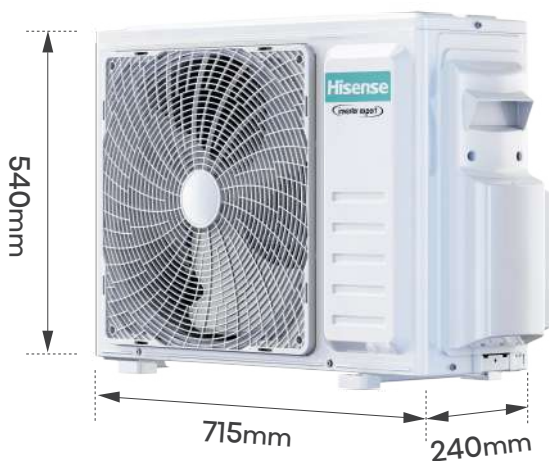

■ Unit Size: Reduced By **10%**

Units Height: Reduced To **0.54m**

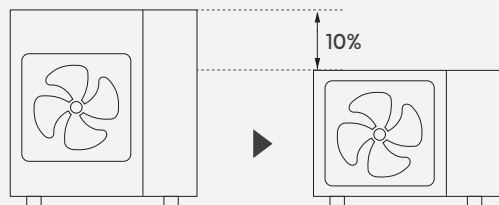

## Multi Split Up To 5

The maximum number of indoor units that the outdoor unit can match is up to 5.

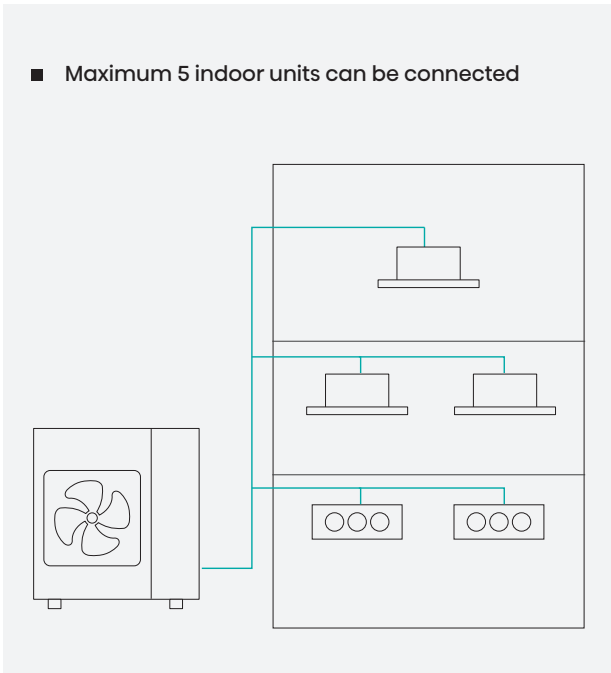

## New Path Design

The reverse path design improves efficiency of the exchanger greatly. Super cooling paths improve the cooling capacity of each unit and lengthen the pipes between the exterior and interior units.

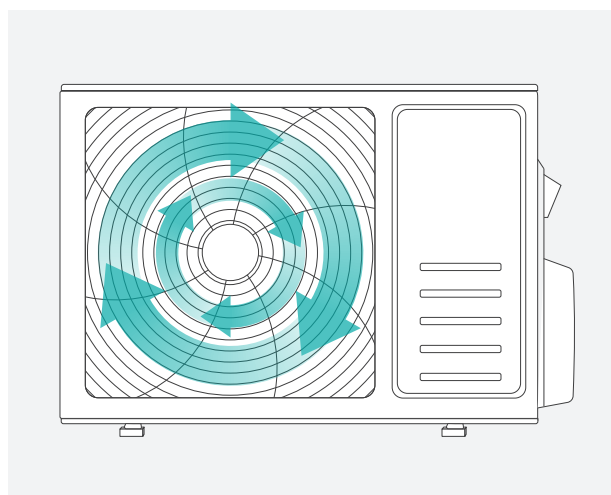

## Big Family

We will have 10 models of the R32 Freematch on sale in the near future, providing customers with more choices than ever.

The whole family of models is fully DC so they can be used in 50Hz or 60Hz countries and regions.

### Combinations Table

|                    | Outdoor Unit Capacity | Indoor Unit Combinations |
|--------------------|-----------------------|--------------------------|
| AMW2-18U4SXE       | 18K-2                 | 6                        |
| AMW3-24U4SADl      | 24K-3                 | 18                       |
| AMW4-28U4SADl      | 28K-3                 | 45                       |
| AMW4-36U4SADl      | 36K-4                 | 52                       |
| AMW-42U4SE+F15E(E) | 42K-5                 | 100                      |
| AMW-48U6SP+F15E(E) | 48K-5                 | 101                      |
| AMW-60U6SP+F15E(E) | 60K-5                 | 113                      |

## Smart Energy Management

Power input can be limited to 70-80% with One-key peak control for energy saving and noise reduction.

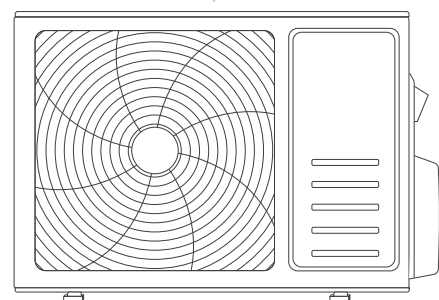
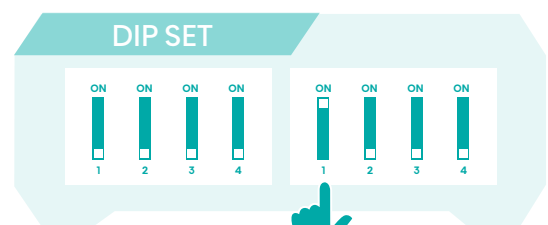





ELECTRICITY



ENERGY SAVING

# DC Fan Outdoor

Free match









-  Auto Restart Function
-  3 Minute Protection
-  Leak Detectives
-  Full DC inverter
-  Hi-smart
-  Compact Design
-  Checker Easy
-  Cooling At -15°C
-  Low Temperature Heating



| Model                      |                    |                   | AMW2-18U4SXE         | AMW4-28U4SAD1        | AMW4-36U4SAD1        | AMW4-48U6SP         |            |
|----------------------------|--------------------|-------------------|----------------------|----------------------|----------------------|---------------------|------------|
| Type(Free Match)           |                    |                   | up to 3 indoor units | up to 4 indoor units | up to 4 indoor units | 3 to 5 indoor units |            |
| Cooling                    | Capacity           | Nominal           | W                    | 7000                 | 8200                 | 10000               | 14200      |
|                            |                    | Nominal           | Btu/h                | 23884                | 27978                | 34120               | 48450      |
|                            |                    | min~max           | W                    | 2400~8000            | 2900~9000            | 3000~11000          | 4800~17000 |
|                            | Input              | Nominal           | W                    | 1800                 | 2200                 | 3100                | 4130       |
|                            | EER                | Nominal           | W/W                  | 3.89                 | 3.73                 | 3.35                | 3.36       |
| Heating                    | Capacity           | Nominal           | W                    | 8400                 | 9000                 | AMW4-36U4SAD1       | 16000      |
|                            |                    | Nominal           | Btu/h                | 28661                | 30708                | #VALUE!             | 54592      |
|                            |                    | min~max           | W                    | 2100~9200            | 2500~10000           | 3000~12000          | 4800~18000 |
|                            | Input              | Nominal           | W                    | 2200                 | 2200                 | 2800                | 4680       |
|                            | COP                | Nominal           | W/W                  | 3.82                 | 4.09                 | 3.93                | 3.34       |
| Air flow                   | ODU                | m <sup>3</sup> /h | 4500                 | 4500                 | 4800                 | 6000                |            |
| Noise Level                | Sound Pressure     | dB(A)             | 59                   | 59                   | 59                   | 60                  |            |
| Guaranteed Operating Range | Sound Power        | dB(A)             | 68                   | 68                   | 68                   | 73                  |            |
|                            | Cooling            | °C                | -15~43               | -15~43               | -15~43               | 7~45                |            |
| Power supply               | Heating            | °C                | -10~24               | -10~24               | -10~24               | -10~24              |            |
|                            | Source             |                   | Outdoor Supply       | Outdoor Supply       | Outdoor Supply       | Outdoor Supply      |            |
| Net Dimension              | Outdoor            | V/Hz/f            | 220-240/50&60/1~     | 220-240/50&60/1~     | 220-240/50&60/1~     | 380-415/50&60/3N~   |            |
| Net Weight                 | WxHxD              | mm                | 950×840×340          | 950×840×340          | 950×840×340          | 950×1386×340        |            |
| Package Dimension          |                    | kg                | 66                   | 67                   | 67                   | 103                 |            |
| Stacking                   | WxHxD              | mm                | 1110×980×460         | 1110×980×460         | 1110×980×460         | 1110×1530×460       |            |
| Gross Weight               | Flat/Sideways      | Layers            | 3/0                  | 3/0                  | 3/0                  | 1/0                 |            |
|                            |                    | kg                | 76                   | 77                   | 77                   | 116                 |            |
| Piping connections         | Diameter(Liquid)   | mm                | 6.35×3               | 6.35×4               | 6.35×4               | 9.52                |            |
|                            | Diameter(Gas)      | mm                | 9.52×3               | 9.52×4               | 9.52×4               | 19.05               |            |
|                            | Max Length(Each)   | m                 | 25                   | 25                   | 25                   | 30                  |            |
|                            | Max Length( Total) | m                 | 60                   | 60                   | 60                   | 100                 |            |
|                            | Max Height         | m                 | 15                   | 15                   | 15                   | 40                  |            |
| Refrigerant                | Type               | -                 | R410A                | R410A                | R410A                | R410A               |            |
|                            | Pre-charged        | g                 | 2200                 | 2600                 | 2600                 | 3350                |            |

# Compact Cassette

Free match

-  Auto Restart Function
-  3 Minute Protection
-  Leak Detective
-  Full DC inverter
-  Hi-smart
-  1 Drive 5
-  Checker Easy
-  Twin Rotary DC Inverter Compressor
-  PCB With Insect Prevention



| Model                                   |                   | ACT-18UR4SAA3   | ACT-21UR4RJC8     |
|---|-------------------|-----------------|-------------------|
| Cooling capacity                        | W                 | 5300(1780-5650) | 7000 (2000-9000)  |
| Heating capacity                        | W                 | 6210(1720-7310) | 8000 (2000-10200) |
| Power Supply                            | V/Hz/f            | 220-240/50/1~   | 220-240/50/1~     |
| Power input (Indoor Unit Only)          | W                 | 77              | 108               |
| Current (Indoor Unit Only)              | A                 | 0.4             | 0.5               |
| Rated power input (Indoor Unit Only)    | W                 | 90              | 130               |
| Rated current (Indoor Unit Only)        | A                 | 0.5             | 0.6               |
| Anti electric shock                     |                   | Class I         | Class I           |
| Degrees of protection                   |                   | IPX0            | IPX0              |
| Air flow                                | m <sup>3</sup> /h | 820             | 1200              |
| Noise Level (Sound Power)               | dB(A)             | 58              | 54                |
| Noise Level H/M/L (Sound Pressure)      | dB(A)             | 45/41/39        | 43/40/37          |
| Net Dimension - Indoor Unit (WxHxD)     | mm                | 650×270×570     | 840×236×840       |
| Net Dimension - Panel (WxHxD)           | mm                | 650×30×650      | 950×50×950        |
| Net Weight - Indoor Unit                | kg                | 21              | 23                |
| Package Dimension - Indoor Unit (WxHxD) | mm                | 770×310×750     | 950×320×950       |
| Package Dimension - Panel (WxHxD)       | mm                | 730×130×730     | 1020×105×1000     |
| Gross Weight - Indoor Unit              | kg                | 26              | 28                |
| Diameter(Liquid)                        | mm                | φ6.35(1/4")     | φ9.52(3/8")       |
| Diameter(Gas)                           | mm                | φ12.7(1/2")     | φ15.88(5/8")      |